

TERMOSTATI DIGITALI DA PARETE CON DISPLAY
WALL MOUNTING DIGITAL THERMOSTATS WITH DISPLAY
THERMOSTATS DIGITAL A ECRAN POUR MONTAGE EN SAILLIE
DIGITALES THERMOSTAT MIT DISPLAY WANDMONTAGE
TERMOSTATOS DIGITALES DE SUPERFICIE CON DISPLAY



Funzionamento Inverno / Estate
2 livelli di temperatura + antigelo

Winter and Summer mode
2 temperature levels + antifreeze

Fonctionnement Hiver ou Eté
2 niveaux de température + antigel

Betrieb Winter oder Sommer
2 Temperaturstufen + Frostschutz

Funcionamiento Invierno / Verano
2 niveles de temperatura + antihielo

MODELLI/MODELS/MODELES/MODELLE/MODELOS:

3V dc
(not included)

L - N: 230V ac

INDICE

DATI TECNICI _____	pag. 3
VISTA GENERALE E FUNZIONI TASTI _____	pag. 4
INSTALLAZIONE _____	pag. 5
ISTRUZIONI D'USO _____	pag. 9
FUNZIONI PROGRAMMABILI DI ADATTAMENTO AL TIPO DI IMPIANTO _____	pag. 11
OPERAZIONE DI RESET _____	pag. 18
EVENTUALI INCONVENIENTI E SOLUZIONI _____	pag. 19

ITALIANO



AVVERTENZE!



Leggere attentamente il presente manuale prima di utilizzare il prodotto in quanto fornisce importanti indicazioni riguardanti la sicurezza, l'installazione e l'uso. Conservare con cura il manuale per successive consultazioni.



L'installazione ed il collegamento elettrico del termostato devono essere eseguiti solo da elettricista qualificato ed in conformità alle norme e leggi vigenti.





Assicurarsi di aver tolto l'alimentazione di rete 230V prima di procedere all'installazione o alla manutenzione.

- Se appare sul display il valore della temperatura ambiente 0 °C o +37.7 °C (+32 °F o +99.9 °F) in modo lampeggiante, significa che la temperatura rilevata è oltre i limiti di scala.
- Se il display visualizza "- - - -" lampeggiante indica sonda guasta, ogni attività di termoregolazione viene sospesa.
- **Modello a 3V dc:** utilizzare solamente 2 pile ministilo alcaline da 1,5V tipo AAA (LR03), l'utilizzo di pile non idonee comporta la possibilità di perdita della programmazione inserita.
N.B.: il prodotto è stato testato e garantisce le sue caratteristiche con pile alcaline DURACELL o ENERGIZER.
- **Modello a 230V ac:** dopo aver installato e impostato il termostato, in caso di assenza di alimentazione di rete il display si spegne salvando tutte le impostazioni effettuate, al ritorno dell'alimentazione di rete il display si accende e il dispositivo ritorna al normale funzionamento.
- In caso di necessità pulire il termostato utilizzando un panno leggermente umido.
- Il costruttore si riserva la facoltà di introdurre tutte le modifiche tecniche e costruttive che riterrà necessarie senza obblighi di preavviso.

DATI TECNICI

IT

Tensione di alimentazione:	_____	modello a pile 2 x 1,5V pile minitilo Alcaline tipo AAA (LR03)
	_____	modello a tensione di rete 230V 50÷60Hz
Autonomia modelli a pile:	_____	circa 2 anni
Autonomia dall'accensione sul display del simbolo lampeggiante  di pile scariche:	_____	circa 1 mese
Tipo di azione, disconnessione ed apparecchio:	_____	1/B/ Elettronico
Tipo di uscita:	_____	relè con contatto in scambio NO / COM / NC libero da potenziale max 5 (3) A / 250V
Software:	_____	Classe A
Tensione impulsiva nominale:	_____	4 kV
Collegamento alimentazione di rete:	_____	2 conduttori (solo modelli alimentazione a 230V~)
Collegamento utenza (carico):	_____	2 o 3 conduttori
Sezione cavi ai morsetti:	_____	1,5 mm ² ÷ 2,5 mm ²
Livelli di Temperatura impostabili:	_____	COMFORT / RIDUZIONE (risparmio) / ANTIGELO (OFF)
Campo di visualizzazione temperatura ambiente:	_____	0 °C ÷ +37,7 °C / +32 °F ÷ +99,9 °F
Risoluzione temperatura ambiente:	_____	0,1°C / 0,1°F
Campo di regolazione T Set di temperatura COMFORT e RIDUZIONE:	_____	+5 °C ÷ +37,7 °C / +41.0 °F ÷ +99,9 °F (limitabile)
Risoluzione temperatura di set:	_____	0,1 °C / 0,1 °F
Temperatura antigelo:	_____	+4 °C ÷ + 12 °C / 39.2 °F ÷ 53.6 °F (regolabile/escludibile)
Tolleranza sulla lettura di temperatura:	_____	± 0,5 °C / ± 0,9 °F
Tipo di regolazione temperatura:		
- ON/OFF con differenziale _____		impostabile da 0,2 °C a 1,2°C / da 0,3 °F a 2,1 °F (default 0,5 °C / 0,9 °F)
- Proporzionale con periodo di controllo _____		impostabile da 7 a 20 minuti (default 10 minuti)
Classificazione energetica ErP:	_____	ErP: Class I; 1% Reg. EU 811/2013
Gradiente termico:	_____	1°K / 15 min
Grado di protezione:	_____	IP 30
Classe isolamento:	_____	II 
Grado di inquinamento:	_____	normale
Limiti Temperatura di funzionamento:	_____	0 °C ÷ +50 °C / +32 °F ÷ +122 °F
Limiti Temperatura di stoccaggio:	_____	-10 °C ÷ +65 °C / +14 °F ÷ +149 °F
Normative di riferimento per marcature CE:	_____	LVD - EMC EN60730-1 EN60730-2-9

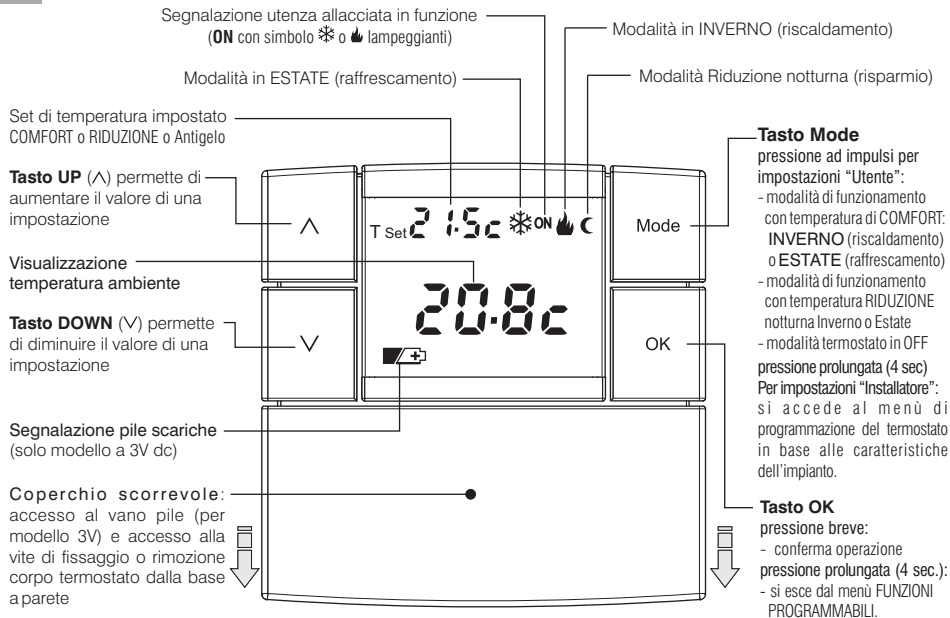

INSTALLAZIONE

IT

ESEMPIO DI INSTALLAZIONE

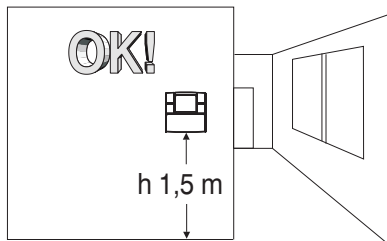

DIMENSIONI DI INGOMBRO

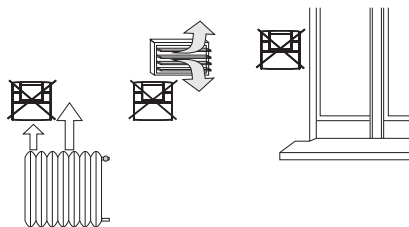
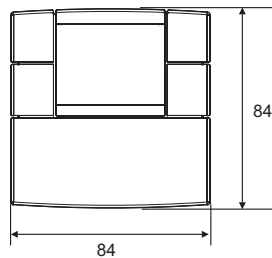

Installare preferibilmente il termostato a quota $1,50 \div 1,60$ m dal pavimento; lontano da sorgenti di calore, prese d'aria, porte o finestre e da quanto possa influenzarne il funzionamento.

Installazione a parete

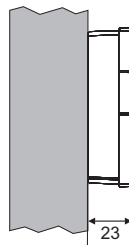

Installazione a parete
su scatola da incasso tonda

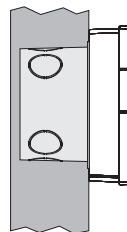

OPERAZIONI PRELIMINARI

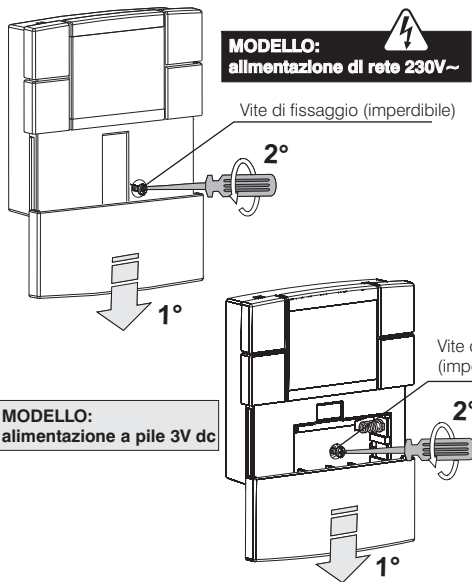

Dopo avere svitato la vite di fissaggio, separare la base dal termostato facendo leva con un cacciavite nell'apposita cava presente nella parte inferiore del dispositivo.

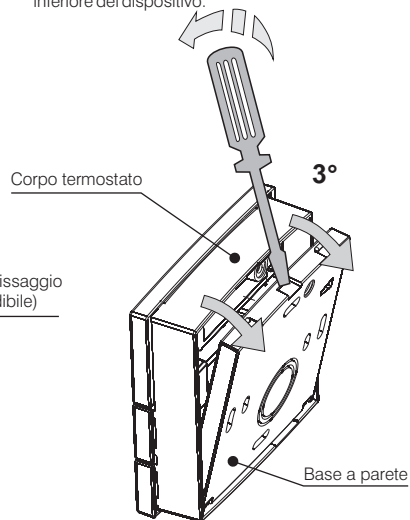

INSTALLAZIONE

IT

BASE A PARETE E MORSETTI

MODELLO: 
alimentazione di rete 230V~

MODELLO:
alimentazione a pile 3Vdc

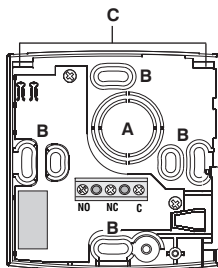
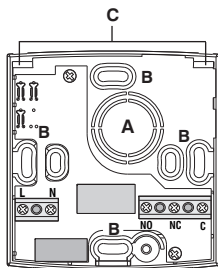



- A - Passaggio fili da:**
Scatola ad incasso tonda o tubo corrugato
- B - Fori di fissaggio della base:**
a parete o su scatola ad incasso tonda
- C - Cave per aggancio termostato**

COLLEGAMENTI ELETTRICI

Disattivare la tensione di rete 230V~ 

Collegare l'alimentazione di rete 230V~ ai morsetti:

L = Linea 
N = Neutro 

Solo per modello con alimentazione a 230V~

Collegare il dispositivo da comandare ai morsetti:

NO = contatto normalmente aperto
NC = contatto normalmente chiuso
C = comune

Esempi di collegamenti elettrici

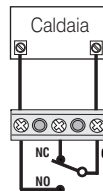

Collegamento
ad una caldaia

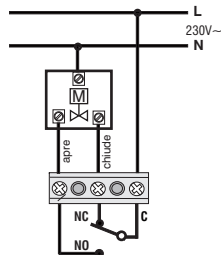

Collegamento ad una
valvola motorizzata

FISSAGGIO E RIMOZIONE DEL TERMOSTATO

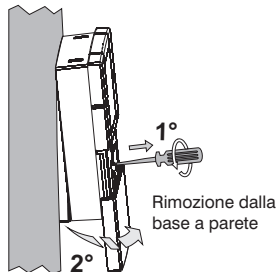
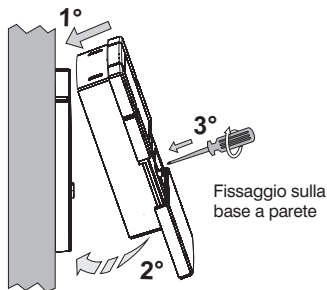

SOLO MODELLO ALIM. A PILE (3Vdc)

INSERIMENTO O SOSTITUZIONE PILE

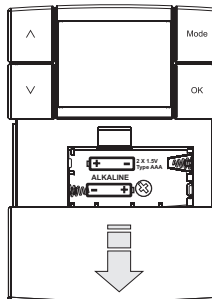

Inserire o sostituire con 2 pile minitipo da 1,5V tipo AAA - LR03 prestando attenzione alle polarità.

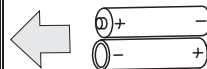

Utilizzare pile alcaline di buona qualità (Consigliate pile Duracell o Energizer).



Smaltire le pile esauste gettandole negli appositi contenitori e comunque secondo quanto prescritto dalle norme sulla tutela dell'ambiente.

Attenzione: la durata delle pile può risultare superiore a 2 anni. Si consiglia comunque di sostituirle almeno ogni 24 mesi per evitare che si esauriscano in periodi di assenza (es. vacanze natalizie ecc.).

MODALITÀ DI FUNZIONAMENTO

Il termostato prevede 5 modalità di funzionamento:

 **INVERNO** = riscaldamento (impostazione di fabbrica)
Con temperatura di **COMFORT**

 **Riduzione notturna inverno** = riscaldamento
con temperatura di **RIDUZIONE** (risparmio)

OFF Termostato spento

- In *funzionamento riscaldamento*: è attiva la modalità temperatura antigelo (se non esclusa durante la programmazione)

- In *funzionamento raffrescamento*: l'impianto è completamente disattivato

 **ESTATE** = raffrescamento
con temperatura di **COMFORT**

 **Riduzione notturna estate** = raffrescamento
con temperatura di **RIDUZIONE** (risparmio)

CAMBIO MODALITÀ DI FUNZIONAMENTO

Cambio da temperatura di COMFORT a temperatura di RIDUZIONE e viceversa

Premere una volta il tasto **Mode**, la relativa simbologia e la temperatura impostata lampeggiano, premere il tasto **OK** entro 5 secondi per confermare.

Cambio da NORMALE FUNZIONAMENTO a OFF

Premere 2 volte il tasto **Mode**, la scritta **OFF** e la temperatura antigelo impostata lampeggiano, premere il tasto **OK** entro 5 secondi per confermare.

Cambio da INVERNO a ESTATE e viceversa

Premere 3 volte il tasto **Mode**, la relativa simbologia e la temperatura impostata lampeggiano, premere il tasto **OK** entro 5 secondi per confermare.

Cambio da OFF a NORMALE FUNZIONAMENTO

Premere una volta il tasto **Mode** per ritornare alla modalità di funzionamento precedente.

esempio: funzionamento riscaldamento attivo

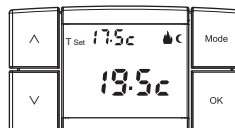
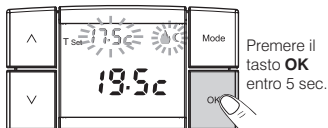
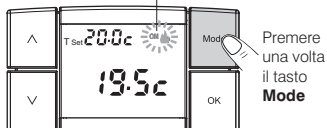

Nelle figure sopra, viene mostrato il passaggio da temperatura di COMFORT a temperatura di RIDUZIONE in modalità INVERNO

MODIFICA TEMPERATURA T Set IMPOSTATA

Dalla modalità in corso è possibile modificare l'impostazione della temperatura T Set agendo direttamente sui tasti \wedge o \vee , la nuova impostazione viene subito memorizzata.

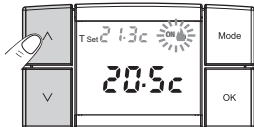

Nota: ogni pressione dei tasti \wedge/\vee comporta la variazione di 0,1 gradi; tenendo premuto si ottiene lo scorrimento veloce dei valori.

Nota: sarà possibile bloccare i Set di temperatura massima in modalità Inverno e/o minima in modalità Estate (vedere cap. FUNZIONI PROGRAMMABILI).

oppure:

Premere una o più volte il tasto **Mode** fino a visualizzare la modalità di funzionamento desiderata.

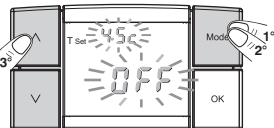

entro 5 secondi,

premere il tasto \wedge per aumentare il valore T Set impostato o il tasto \vee per diminuirlo.

Trascorsi 5 secondi dall'ultima pressione di un tasto il termostato riprende il funzionamento precedente.

Nota: se è stata esclusa la temperatura antigelo (vedere cap. FUNZIONI PROGRAMMABILI) l'utente non potrà impostare il Set di temperatura antigelo.

IMPORTANTE! Il termostato consente impostazioni di T Set da +5 °C a 37,7 °C (+41,0 °F ÷ +99,9 °F) con valori di temperatura che soddisfino le seguenti condizioni:

Inverno: impostazione temperatura "Comfort" maggiore o uguale a temperatura di Riduzione inverno

Estate: impostazione temperatura di "Comfort" minore o uguale a temperatura di "Riduzione" estate.

Le temperature T Set impostate di fabbrica sono le seguenti:

	<p>Modalità inverno (riscaldamento): temperatura Comfort 20,0 °C / 68,0 °F Caldaia in funzione con temperatura ambiente inferiore a 20,0 °C / 68,0 °F</p>
	<p>Riduzione notturna inverno: temperatura "Riduzione" 17,5 °C / 63,5 °F Caldaia in funzione con temperatura ambiente inferiore a 17,5 °C / 63,5 °F</p>
	<p>Modalità estate (raffrescamento): temperatura "Comfort" 25,0 °C / 77,0 °F Condizionatore in funzione con temperatura ambiente superiore a 25,0 °C / 77,0 °F</p>
	<p>Riduzione notturna estate: temperatura "Riduzione" 28,0 °C / 82,4 °F Condizionatore in funzione con temperatura ambiente superiore a 28,0 °C / 82,4 °F</p>
OFF	<p>Termostato spento: temperatura Antigelo 4,0 °C / 39,2 °F (regolabile o escludibile) - Caldaia in funzione con temperatura ambiente inferiore a 4,0 °C / 39,2 °F - Condizionatore disattivato</p>

ISTRUZIONI D'USO

SOLO MODELLO ALIMENTAZIONE A PILE (3Vdc)

SEGNALAZIONE PILE QUASI SCARICHE O SCARICHE

La comparsa del simbolo  lampeggiante indica che le pile si stanno esaurendo, da questo momento si hanno circa 30 giorni di tempo per effettuare la sostituzione.

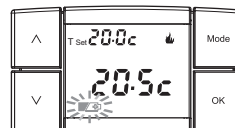

Se non si sostituiscono le pile quasi scariche nei tempi dichiarati si spegnerà il display visualizzando solo il simbolo  fisso.

Ogni attività di termoregolazione viene sospesa e tutte le impostazioni vengono memorizzate per essere ripristinate all'inserimento delle nuove pile.

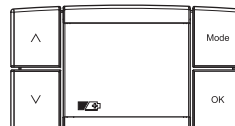

SOLO MODELLO ALIMENTAZIONE 230V ac

MANCANZA TENSIONE DI RETE

in caso di assenza di alimentazione di rete il display del termostato si spegne completamente disattivando la termoregolazione e salvando tutte le impostazioni effettuate in un'apposita memoria, al ritorno dell'alimentazione di rete il display si accende e il dispositivo ritorna al normale funzionamento.

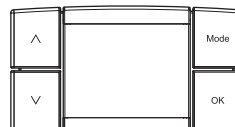

ACCESSO ALLA PROGRAMMAZIONE

L'accesso alla programmazione è consigliato **all'installatore o ad utenti esperti** in quanto la modifica di alcune impostazioni potrebbe compromettere il corretto funzionamento dell'impianto.

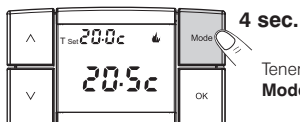

4 sec.

Tenere premuto il tasto **Mode** per 4 sec.

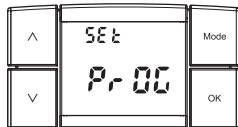

Sul display appare per alcuni istanti la scritta SET PROG.

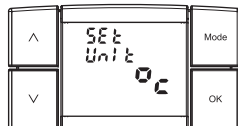

In seguito il termostato si dispone sulla pagina dell'impostazione dell'unità di misura.

All'interno del menù di programmazione si passa da una funzione all'altra premendo ad impulsi il tasto **Mode** e sono, in sequenza, le seguenti:

- Impostazione della scala delle temperature (°C o °F)
- Correzione della temperatura ambiente misurata (OFFSET)
- Blocchi dei Set di temperatura
- Selezione della modalità di regolazione della temperatura: (DIFFERENZIALE ON/OFF o PROPORZIONALE)
- Modifica del valore di isteresi impostato (Differenziale on/off)
- Modifica del ciclo di durata impostato (Proporzionale)
- Esclusione o impostazione temperatura antigelo

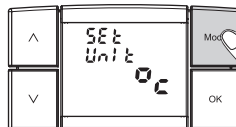

Premere il tasto **Mode** una più volte per passare da una funzione all'altra.

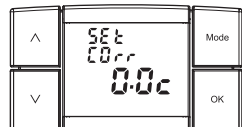

IMPORTANTE: per uscire dal menù di programmazione includendo le eventuali nuove impostazioni confermate con il tasto OK, agire nel seguente modo:

Premere per 4 secondi il tasto OK, oppure attendere 60 secondi (time-out); il termostato ritorna al normale funzionamento.

IMPOSTAZIONE DELLA SCALA DELLE TEMPERATURE

Il termostato è predisposto in fabbrica per la visualizzazione delle temperature in gradi Centigradi (Celsius), sarà possibile passare alla scala Fahrenheit o viceversa come da seguente procedura:

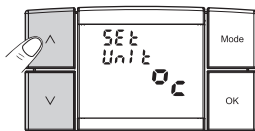

Premere il tasto \wedge o \vee per modificare l'impostazione attuale.

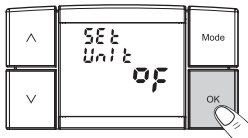

Premere il tasto **OK** per memorizzare e passare all'impostazione successiva oppure tenerlo premuto per almeno 4 sec per salvare la nuova impostazione e uscire dal menù di programmazione.

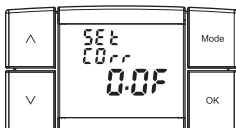

CORREZIONE LETTURA TEMPERATURA AMBIENTE

Se per qualsiasi motivo il termostato deve essere installato in una posizione per cui la temperatura misurata possa esserne influenzata (es. il muro perimetrale che in inverno è mediamente più freddo del resto dell'abitazione) è possibile impostare un Offset (valore di correzione) della temperatura misurata, la correzione è impostabile da -2°C a $+2^{\circ}\text{C}$ o da -3.6 a $+3.6^{\circ}\text{F}$.

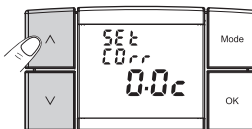

Premere il tasto \wedge o \vee per modificare l'impostazione attuale.



Premere il tasto **OK** per memorizzare e passare all'impostazione successiva oppure tenerlo premuto per almeno 4 sec per salvare la nuova impostazione e uscire dal menù di programmazione.

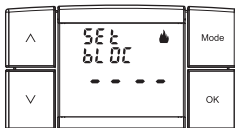

BLOCCO SET DI TEMPERATURA MAX (inverno) e MIN (estate)

In alcuni casi particolari di installazione del termostato, ad esempio in edifici pubblici, alberghi ecc., potrebbe essere utile limitare la set di temperatura comfort in modo da evitare impostazioni errate da parte di personale non autorizzato.

Sarà quindi possibile limitare i valori di Set temperatura massima se il termostato è in modalità  **Inverno** (riscaldamento), oppure limitare i valori di Set temperatura minima se il termostato è in modalità  **Estate** (raffrescamento).

Nella configurazione di base non viene impostato alcun blocco.

Esempio: blocco del set di temperatura Comfort massima per la modalità Inverno (riscaldamento)

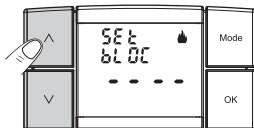

Tramite i tasti \wedge o \vee impostare il valore di blocco della temperatura massima.

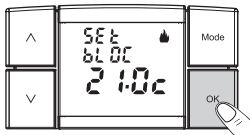

Premere il tasto **OK** per memorizzare e passare all'impostazione del blocco per il  **Raffrescamento** oppure tenerlo premuto per almeno 4 secondi per salvare la nuova impostazione e uscire dal menù di programmazione.

Esempio: blocco del set di temperatura Comfort minima per la modalità Estate (raffrescamento)

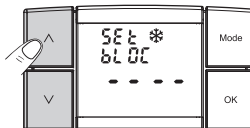

Tramite i tasti \wedge o \vee impostare il valore di blocco della temperatura minima.



Premere il tasto **OK** per memorizzare e passare all'impostazione successiva oppure tenerlo premuto per almeno 4 secondi per salvare la nuova impostazione e uscire dal menù di programmazione.

Nota: per annullare eventuali blocchi precedentemente impostati riportare i Set a - - - -

MODALITÀ DI REGOLAZIONE DELLA TEMPERATURA

Il termostato funziona (impostazione di fabbrica) in modo **DIFFERENZIALE (ON/OFF)** con valore del differenziale termico (**Isteresi**) prefissato a **0,5 °C** (impostabile da 0,2 °C a 1,2 °C).

Il valore dell'Isteresi deve essere impostato in base all'inerzia termica dell'impianto, si consiglia un valore basso per impianti con radiatori (es. in ghisa) ed un valore alto per impianti con Fan coil.

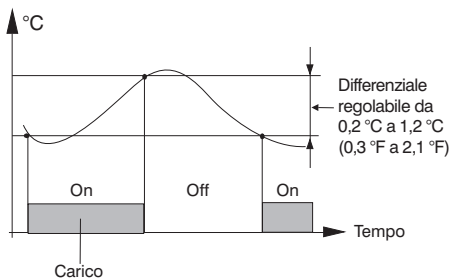

In alternativa al differenziale è possibile regolare la temperatura in modo **PROPORZIONALE (PROP)**; la durata del ciclo è impostabile da 7 a 20 minuti (impostazione di fabbrica 10 minuti). Questo sistema permette di mantenere più stabile la temperatura desiderata, aumentando la sensazione di comfort per l'utente e risparmiando sui consumi energetici.

Esempio di impostazione:

T set = 20 °C - Ciclo = 10 minuti

t = 20,5 °C	Utenza sempre spenta
t = 20,4 °C	Utenza 1 min ON - 9 min OFF
t = 20,3 °C	Utenza 2 min ON - 8 min OFF
t = 20,2 °C	Utenza 3 min ON - 7 min OFF
t = 20,1 °C	Utenza 4 min ON - 6 min OFF
t = 20,0 °C	Utenza 5 min ON - 5 min OFF
t = 19,9 °C	Utenza 6 min ON - 4 min OFF
t = 19,8 °C	Utenza 7 min ON - 3 min OFF
t = 19,7 °C	Utenza 8 min ON - 2 min OFF
t = 19,6 °C	Utenza 9 min ON - 1 min OFF
t = 19,5 °C	Utenza sempre accesa

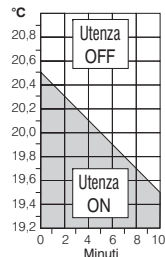

Si consiglia un ciclo lungo per impianti con inerzia termica alta (radiatori in ghisa, impianti a pavimento) ed un ciclo breve per impianti con inerzia termica bassa (fan- coil).

Scegliere la modalità di regolazione della temperatura e impostare i relativi valori secondo le caratteristiche del Vs. impianto come indicato nei paragrafi successivi.

SELEZIONE DELLA MODALITÀ DI REGOLAZIONE DELLA TEMPERATURA (DIFFERENZIALE ON/OFF o PROPORZIONALE)

Questa procedura consente di selezionare la modalità di regolazione della temperatura tra funzionamento **Differenziale ON:OFF** (impostazione di fabbrica) e **Proporzionale PROP.**

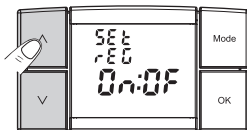

Tramite i tasti \wedge o \vee impostare la modalità di regolazione della temperatura desiderata.

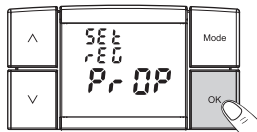

Premere il tasto **OK** per memorizzare e passare all'impostazione successiva oppure tenerlo premuto per almeno 4 sec per salvare la nuova impostazione e uscire dal menù di programmazione.

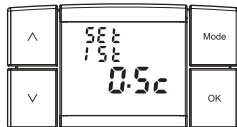

IMPOSTAZIONE DELL'ISTERESI

Il valore dell'Isteresi per la modalità di regolazione **ON:OFF** deve essere impostato in base all'inerzia termica dell'impianto, si consiglia un valore basso per impianti con radiatori (es. in ghisa) ed un valore alto per impianti con fan coil. Il valore è impostabile da 0,2 °C a 1,2 °C (0,3 °F a 2,1 °F); l'impostazione di fabbrica è 0,5 °C (0,9 °F).

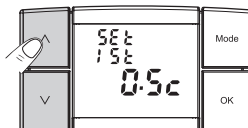

Tramite i tasti \wedge o \vee impostare il valore dell'isteresi



Premere il tasto **OK** per memorizzare e passare all'impostazione successiva oppure tenerlo premuto per almeno 4 sec per salvare la nuova impostazione e uscire dal menù di programmazione.

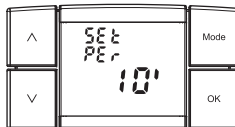

DURATA CICLO PROPORZIONALE

La durata del ciclo di controllo per il funzionamento nella modalità PROPORZIONALE (PROP) è impostabile da 7 a 20 minuti; si consiglia un ciclo lungo per impianti con inerzia termica alta (radiatori in ghisa, impianti a pavimento) ed un ciclo breve per impianti con inerzia termica bassa (fan-coil). L'impostazione di fabbrica è 10 minuti.

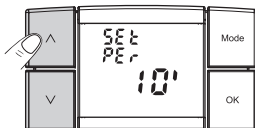

Tramite i tasti \wedge o \vee impostare la durata del ciclo di controllo proporzionale.

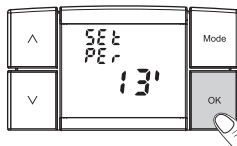

Premere il tasto **OK** per memorizzare e passare all'impostazione successiva oppure tenerlo premuto per almeno 4 secondi per salvare la nuova impostazione e uscire dal menù di programmazione.

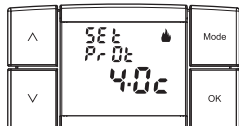

REGOLAZIONE O ESCLUSIONE PROTEZIONE ANTIGELO

Nella modalità di funzionamento **OFF**, il termostato è programmato per proteggere l'impianto in caso di gelo quando la temperatura scende sotto i $+4.0^{\circ}\text{C}$ ($+39.2^{\circ}\text{F}$); questa impostazione è regolabile da $+4.0^{\circ}\text{C}$ a $+12.0^{\circ}\text{C}$ ($+39.2^{\circ}\text{F}$ ÷ $+53.6^{\circ}\text{F}$).

È possibile escludere questa funzione. In questo caso l'impianto sarà esposto ad eventuali danni causati dal gelo.

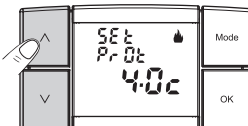

Tramite i tasti \wedge o \vee impostare il valore di temperatura antigelo desiderata.

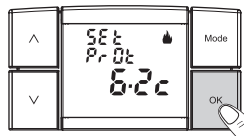

Premere il tasto **OK** per memorizzare e ritornare all'impostazione della scala $^{\circ}\text{C}/^{\circ}\text{F}$ oppure tenerlo premuto per almeno 4 secondi per salvare la nuova impostazione e uscire dal menù di programmazione.

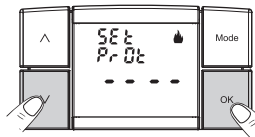

Se invece si desidera escludere la protezione antigelo, premere il tasto \vee fino a visualizzare sul display ---- e confermare con il tasto **OK** come descritto sopra.

RESET

L'operazione di Reset è consigliata **all'installatore o ad utenti esperti** in quanto con questa operazione tutte le impostazioni e programmazioni precedentemente eseguite secondo la tipologia dell'impianto verranno perse.

Terminata l'operazione di Reset il termostato ripristina tutte le impostazioni di fabbrica.

Premere contemporaneamente i 4 tasti del termostato e tenerli premuti per almeno 4 secondi.

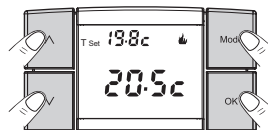

Tutti i segmenti del display si accendono per qualche istante.

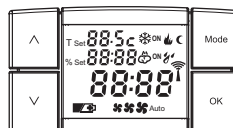

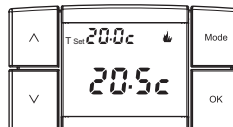

Il termostato riprende il funzionamento nella modalità Riscaldamento (inverno), ripristinando tutte le impostazioni di fabbrica.



EVENTUALI INCONVENIENTI E SOLUZIONI

IT

INCONVENIENTE	CAUSA	SOLUZIONE
Il display del termostato è spento <i>(modello a 3Vdc)</i>	Pile non installate Polarità pile errata Pile esaurite	Controllare che le pile siano installate Verificare la polarità delle pile Sostituire le pile
Il display del termostato è spento <i>(modello a 230V ac)</i>	Manca tensione di rete	Controllare che l'interruttore o differenziale di protezione non sia in OFF
Sul display è comparso il simbolo  lampeggiante	Le pile stanno per esaurirsi	Sostituire le pile entro 30 giorni
Sul display compare solamente il simbolo  fisso	Le pile sono esaurite	Sostituire le pile
Il termostato funziona ma l'impianto non viene attivato	Manca tensione all'impianto Il termostato non è collegato correttamente	Controllare che l'interruttore o differenziale di protezione non sia in OFF Contattare l'installatore
La temperatura oscilla troppo tra caldo e freddo	Il termostato non è impostato correttamente per il tipo di impianto	Contattare l'installatore
In funzionamento OFF il set di temperatura antigelo non è visualizzato	La temperatura antigelo è stata esclusa	Impostare la temperatura antigelo seguendo le indicazioni riportate nel cap. FUNZIONI PROGRAMMABILI

INDEX

TECHNICAL DATA	page 21
GENERAL VIEW AND KEY FUNCTIONS	page 22
INSTALLATION	page 23
USER INSTRUCTIONS	page 27
PROGRAMMABLE FUNCTIONS TO ADAPT TO THE TYPE OF INSTALLATION	page 30
RESET OPERATION	page 36
EVENTUAL FAULTS AND SOLUTIONS	page 37

ENGLISH



WARNING



Read this manual carefully before using the product because it contains important indications regarding safety, installation and use. Keep this manual available for further consultation.



The installation and electrical connection of the devices and appliances must be implemented by person with electrotechnical expertise only and in conformity with current laws and regulations.



Before starting any operations on the device, disconnect the 230V~ mains power supply

- If the display flashes the room temperature at 0 °C o +37.7 °C (+32 °F o +99.9 °F) it means that the measured temperature is over the scale limit.
- If the display flashes " - - - - " this means that the probe is not working, all thermoregulation activity is suspended.
- **3V dc model:** use only two stilo alkaline 1.5V batteries type AAA (LR03); fitting inappropriate batteries could lead to loss of the entered programming.
N.B.: this product has been tested and guarantees all its characteristics with DURACELL or ENERGIZER alkaline batteries.
- **230V ac model:** after installing and setting the thermostat, in case of absence of power supply the display switches off saving all the programmed settings effected, when power supply is reinstated, the display switches back on and the device returns to its normal functions.
- When required, wipe the thermostat with a slightly damp cloth.
- The manufacturer has the faculty to introduce all the technical and production changes which will be deemed necessary with no obligation of prior notice.

TECHNICAL DATA

EN

Power supply: _____ **battery model** 2 x 1,5V **Alkaline** ministilo type AAA (LR03);
_____ **line voltage model** 230V 50÷60Hz

Battery model life: _____ aprox. 2 years

Time of autonomy from the  flash indicating

low battery: _____ 1 month

Type of action, disconnection and device: _____ 1/B/Electronic

Type of output: _____ relay with exchange contact NO/COM/NC no potential
max 5 (3) A / 250V

Software: _____ Class A

Nominal pulse voltage: _____ 4 kV

Connection to line voltage: _____ 2 conductors (only for 230V~ ac models)

Load voltage: _____ 2 or 3 conductors

Cables and terminals section: _____ 1,5 mm² ÷ 2,5 mm²

Levels of Temperature: _____ COMFORT and NIGHT ECONOMY + antifreeze

Room temperature display field: _____ 0 °C ÷ +37,7 °C / +32 °F ÷ +99,9 °F

Room temperature resolution: _____ 0,1°C / 0,1°F

T set Temperature regulation field: _____ +5 °C ÷ +37,7 °C / +41.0 °F ÷ +99,9 °F (limitable)

Set temperature resolution: _____ 0,1 °C / 0,1 °F

Antifreeze temperature: _____ +4 °C ÷ + 12 °C / 39.2 °F ÷ 53.6 °F (adjust/exclude)

Tolerance on temperature reading: _____ ± 0,5 °C / ± 0,9 °F

Type of temperature regulation:

- ON/OFF with differential _____ setting from 0,2 °C to 1,2°C / from 0,3 °F to 2,1 °F (default 0,5 °C / 0,9 °F)

- Proportional with control period _____ setting from 7 to 20 minutes (default 10 minutes)

Energy classification: _____ ErP: Class I; 1% Reg. EU 811/2013

Thermal gradient: _____ 1°K / 15 min

Protection degree: _____ IP 30

Isolation class: _____ II 

Pollution degree: _____ normal

Running temperature limit: _____ 0 °C ÷ +50 °C / +32 °F ÷ +122 °F

Storage temperature limit: _____ -10 °C ÷ +65 °C / +14 °F ÷ +149 °F

Norms of reference for EC branding: _____ LVD - EMC EN60730-1 EN60730-2-9

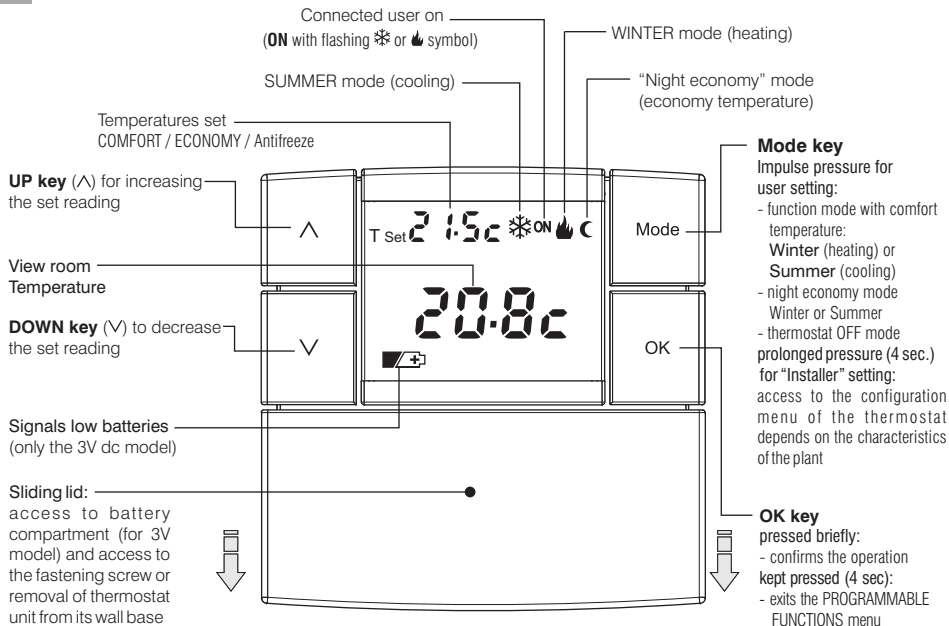

INSTALLATION

EN

EXAMPLE OF INSTALLATION

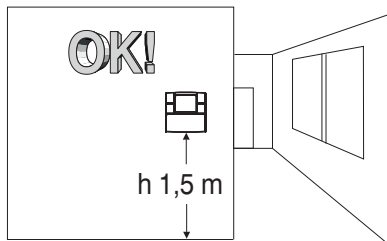

DIMENSIONS

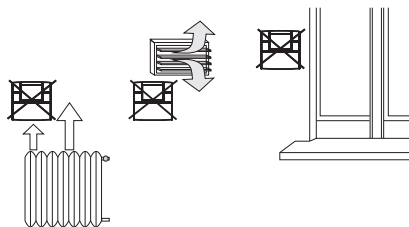
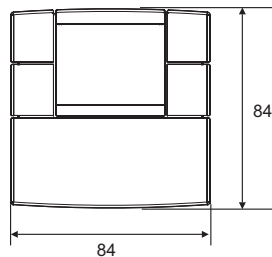

It is preferable to install the thermostat at $1.50 \div 1.60$ m from the floor, far from heat sources, air vents, doors or windows and whatever might influence its function.

Wall fitting

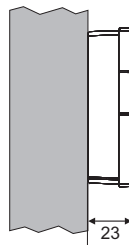

Wall fitting
on round recess box

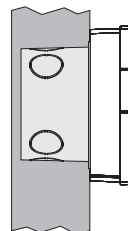

PRELIMINARY OPERATIONS

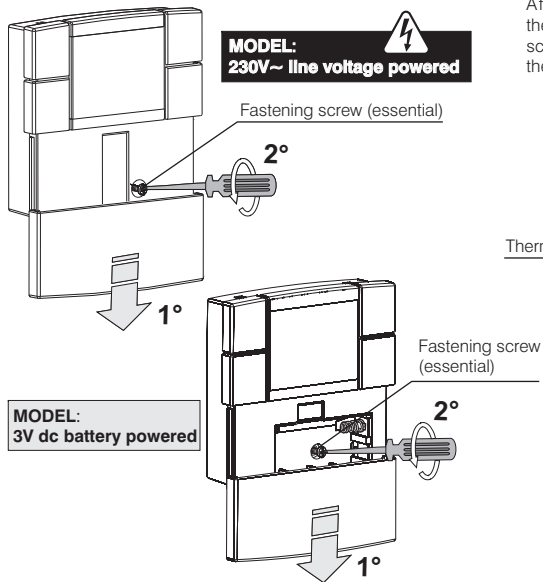

After loosening the screw, separate the thermostat from its base by levering with the screwdriver in the special slot in the lower part of the device.

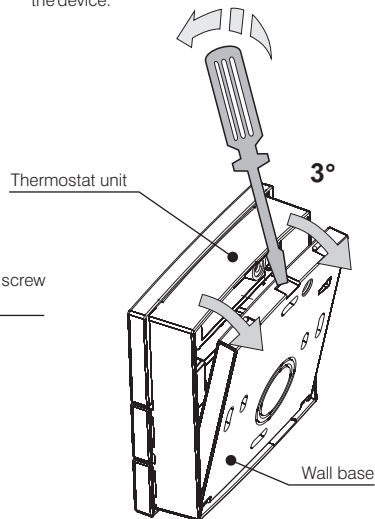

INSTALLATION

EN

WALL BASE AND TERMINALS

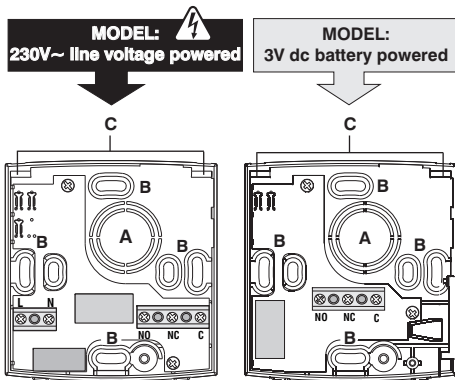

- A - Wire passage from:**
Round recess box or corrugated tube
- B - Base fixing holes:**
for fitting on the wall or round recess box
- C - Slot for hooking thermostat**

ELECTRIC CONNECTIONS

Disconnect 230V~ line voltage

Connect 230V~ line voltage power supply to the terminals:

L = Line

N = Neutral



Only for the 230V~ line voltage powered model

Connect the device to the terminals:

NO = contact normally open

NC = contact normally closed

C = common

Examples of electrical connections

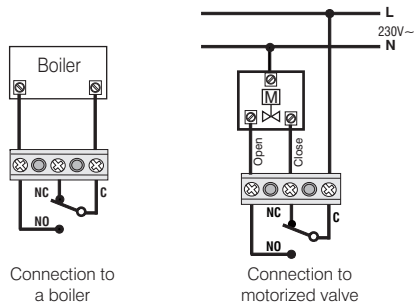

FIXING AND REMOVING THE THERMOSTAT

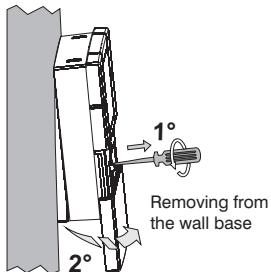
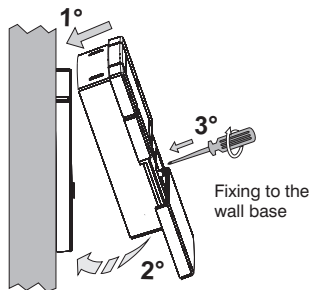

ONLY IN THE BATTERY-POWERED MODEL (3VDC)

FITTING OR REPLACING BATTERIES

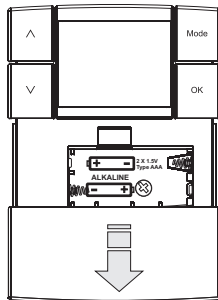

Fit or replace 2 minitilo 1.5V batteries type AAA-LR03 paying attention to the polarity.

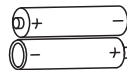

Use higher quality alkaline batteries (Duracell or Energizer batteries recommended).



Dispose of the old batteries in the special containers and anyway according to the environment protection laws





Attention: battery life may be more than 2 years. However, it is recommended to replace them at least every 24 months to avoid them running out when you are away (e.g. Christmas holidays, etc.)

USER INSTRUCTIONS

EN

FUNCTION MODES

This thermostat has 5 function modes:

 WINTER = heating (by default) with COMFORT temperature
 Winter night economy = heating with ECONOMY temperature (economy)
OFF Thermostat off - <i>In heating mode:</i> antifreeze temperature mode is activated (if not excluded during setting) - <i>In cooling mode:</i> the system is completely deactivated
 SUMMER = cooling With COMFORT temperature
 Summer night economy = cooling with ECONOMY temperature (economy)

CHANGING FUNCTION MODE

Changing from COMFORT temperature to ECONOMY temperature and viceversa

Press **Mode** once. The symbol and the set temperature will start flashing; press **OK** within 5 seconds to confirm.

Changing from NORMAL FUNCTION to OFF

Press **Mode** twice. The word OFF and the set antifreeze temperature will start flashing; press **OK** within 5 seconds to confirm.

Changing from WINTER to SUMMER and viceversa

Press **Mode** 3 times.

The symbol and the set temperature will start flashing; press **OK** within 5 seconds to confirm.

Changing from OFF to NORMAL FUNCTION

Press **Mode** once to return to the previous function mode.

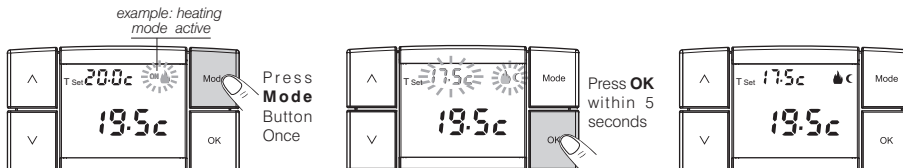

The figure above shows how to switch from WINTER mode with COMFORT temperature to ECONOMY temperature

CHANGE T set TEMPERATURE DEFAULT

From the current mode it is possible to change the setting of the T Set temperature by directly pressing the \wedge or \vee key, the new setting will be instantly stored.

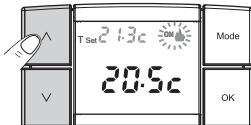

Note: every time a \wedge or \vee key is pressed a variation of 0.1 degrees is set; a faster flow of readings is achieved by holding the key pressed.

Note: The maximum and minimum temperature settings can be blocked (refer to the PROGRAMMABLE FUNCTIONS chapter).

Or:

Press one or more times the **Mode** key until the required function mode is displayed.
within 5 seconds, press the \wedge key to increase the **T Set** reading or the \vee key to reduce it.

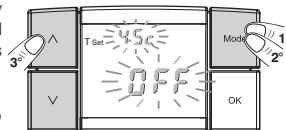

After 5 seconds from pressing a key the thermostat will regain the previous function

Note: if the antifreeze temperature is deselected (refer to the PROGRAMMABLE FUNCTIONS chapter) the user cannot change the anti-freeze temperature setting.

IMPORTANT: the thermostat temperature can be set from +5 °C to 37,7 °C (+41,0 °F ÷ +99,9 °F) with temperature readings which satisfy the following conditions:

Winter: "Comfort" temperature setting higher or the same as the winter economy temperature

Summer: "Comfort" temperature setting lower or the same as summer economy temperature.

The T set temperature manufacturer's default are the following:



Winter Mode (heating):

"Comfort" temperature **20,0 °C / 68,0 °F**

Boiler functioning on room temperature less than 20,0 °C / 68,0 °F



Night economy winter:

"Economy" temperature **17,5 °C / 63,5 °F**

Boiler functioning on room temperature less than 17,5 °C / 63,5 °F



Summer mode (cooling):

"Comfort" temperature **25,0 °C / 77,0 °F**

Air conditioner functioning on room temperature in excess of 25,0 °C / 77,0 °F



Night economy summer:

"Economy" temperature **28,0 °C / 82,4 °F**

Air conditioner functioning on room temperature in excess of 28,0 °C / 82,4 °F

OFF Thermostat off (Anti-freeze mode)

Anti-freeze temperature 4.0 °C / 39.2 °F (adjustable or excludable)

- Boiler functioning on room temperature less than 4,0 °C / 39,2 °F

- Air conditioning off

USER INSTRUCTIONS

EN

ONLY in the BATTERY-POWERED MODEL (3Vdc)

BATTERIES LOW OR FLAT SIGNAL

the flashing of the  symbol indicates that the batteries are low, from this moment on there are aprox. 30 days time to replace the batteries.

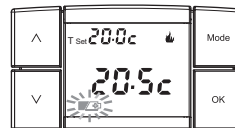

If the low batteries are not replaced within the declared time, the display will turn off leaving only a fixed  symbol.

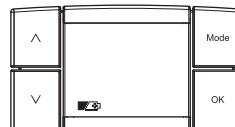

Every heat regulation is suspended and all settings are stored to be reactivated once batteries have been replaced.

ONLY In the 230V ac POWERED MODEL

ABSENCE OF LINE POWER SUPPLY

In case of absence of power supply the thermostat display switches off completely deactivating heat regulation and saving and storing all settings effected, when the power supply resumes, the display switches on again and the device returns to its normal function.

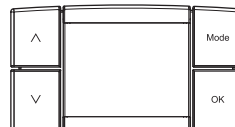

ACCESS TO PROGRAMMING

It is preferable that programming is accessed by the **installer or expert user** since changing some of the default settings could compromise the correct function of the installation.

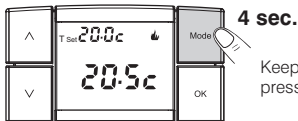

Keep the **Mode** key pressed for 4 seconds.

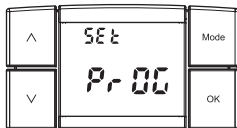

SET PROG will appear on the display for a few seconds.

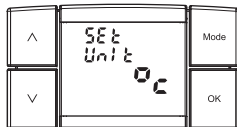

Then, the thermostat displays the measure unit set page.

In the program menu you access the various functions impulse pressing the **Mode** key, these being in sequence:

- Set scale of temperatures (°C or °F).
- Adjust measured room temperature (OFFSET).
- Block temperature set.
- Select temperature regulation mode: (DIFFERENTIAL ON/OFF or PROPORTIONAL).
- Change hysteresis set readings (Differential on/off).
- Change set time cycle (Proportional).
- Adjust or Exclude set antifreeze temperature.

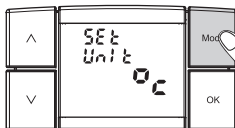

Press **Mode** key one or more times to pass from one function to another.

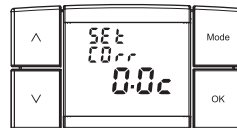

IMPORTANT: to exit the Programs menu including any new settings, confirm by pressing OK as follows: **Press OK for 4 seconds or wait 60 seconds (time-out);** the thermostat returns to normal operation.

SETTING OF THE TEMPERATURE SCALE

The thermostat is preset in production for viewing the temperatures in Celsius degrees, it is possible however to change to the Fahrenheit scale or viceversa with the following procedure:

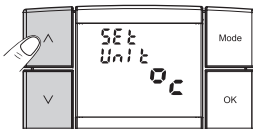

Press the \wedge or \vee key to change the current setting

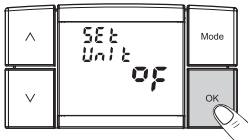

Press the **OK** key to save and move to the following setting or keep it pressed for at least 4 seconds to save the new setting and exit the program menu

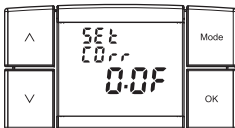

ADJUSTMENT OF ROOM TEMPERATURE READING

If for any reason the thermostat is installed in a position for which the measured temperature might be influenced (eg. an external wall which in the winter is on average colder than the rest of the house) it is possible to set an Offset (adjustment reading) of the measured temperature, the adjustment which can be set is from -2°C to $+2^{\circ}\text{C}$ or from -3.6 to $+3.6^{\circ}\text{F}$.

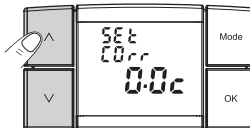

Press the \wedge or \vee key to change current setting

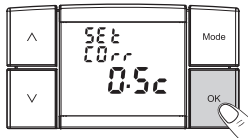

Press the **OK** key to save and move on to the following setting or keep it pressed for at least 4 seconds to save the new setting and exit the program menu

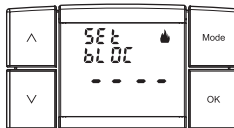

BLOCK MAX TEMPERATURE SETTING (winter) and MIN TEMPERATURE (summer)

In particular cases of thermostat installation, eg. In public buildings, hotels etc. it could be useful to limit the temperature set to comfort in order to avoid erroneous settings by non authorized personnel.

It is therefore possible to limit the maximum temperature settings if the thermostat is in 🔥 **Winter** mode (heating) or limit the minimum temperature setting of the thermostat is in ❄️ **Summer** mode (cooling).

In the default configuration no block has been set.

Example: block maximum Comfort temperature Winter mode (heating)

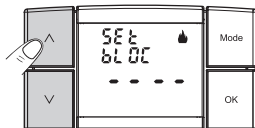

Press the **^** or **V** key to set the maximum temperature block reading.

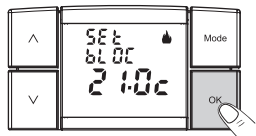

Press the **OK** key to save and pass on to the ❄️ **Cooling** block setting or keep it pressed for at least 4 seconds to save the new setting and exit program menu.

Example: block minimum Comfort temperature for Summer mode (cooling)

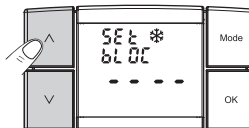

Press the **^** or **V** key to set the minimum temperature block reading.



Press the **OK** key to save and pass on to the subsequent setting or keep pressed for at least 4 seconds to save the new setting and exit program menu.

Note: any previously blocked settings are cancelled by setting - - - -

TEMPERATURE REGULATION

The thermostat has been manufactured to work in **differential mod (ON/OFF)** with thermal differential reading (**hysteresis**) preset at **0.5 °C** (setting from 0,2 °C to 1,2 °C) .

The hysteresis reading must be set on the basis of the thermal inertia of the system; a low reading is advisable for systems with radiators (eg, in cast iron) and a high reading for fan coil systems.

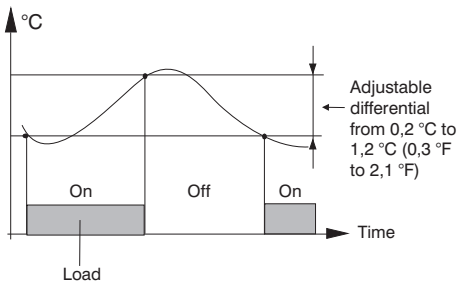

As opposed to the differential, the temperature can be adjusted **PROPORTIONALLY (PROP)** setting cycles from 7 to 20 minutes (default 10 minutes)

This system maintains the desired temperature more stable, whilst increasing the user's comfort sensation and saving on energy consumption

Setting example:

t set = 20 °C - Cycle = 10 min

t = 20,5 °C	Always off
t = 20,4 °C	Use 1 min ON - 9 min OFF
t = 20,3 °C	Use 2 min ON - 8 min OFF
t = 20,2 °C	Use 3 min ON - 7 min OFF
t = 20,1 °C	Use 4 min ON - 6 min OFF
t = 20,0 °C	Use 5 min ON - 5 min OFF
t = 19,9 °C	Use 6 min ON - 4 min OFF
t = 19,8 °C	Use 7 min ON - 3 min OFF
t = 19,7 °C	Use 8 min ON - 2 min OFF
t = 19,6 °C	Use 9 min ON - 1 min OFF
t = 19,5 °C	Always on

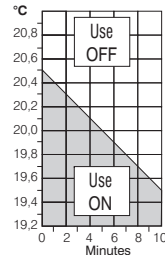

It is advisable to set a long cycle in systems with high thermal inertia (cast iron radiators, floor heating systems) and a short cycle in systems with low thermal inertia (fan coil).

Choose the temperature adjustment method and set the relative values in accordance with the characteristics of your system as shown in the following paragraphs.

SELECT TEMPERATURE ADJUSTMENT MODES (DIFFERENTIAL ON/OFF or PROPORTIONAL)

This procedure enables the selection of the temperature adjustment modes between the Differential **ON:OFF** (manufacturer's default) and Proportional **PROP**.

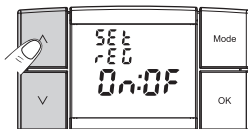

Press the \wedge or \vee key to set the required temperature adjustment mode.

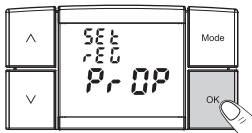

Press the **OK** key to save and pass on to the subsequent setting or keep pressed for at least 4 seconds to save the new setting and exit program menu.

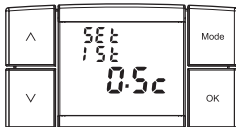

SETTING OF THE HYSTERESIS

The hysteresis reading in the **ON:OFF** adjustment mode must be set on the basis of the thermal inertia of the system; a low reading is advisable for systems with radiators (eg, in cast iron) and a high reading for fan coil systems. The readings which can be set from 0,2 °C to 1,2 °C (0,3 °F to 2,1 °F); the default reading is 0,5 °C (0,9 °F).

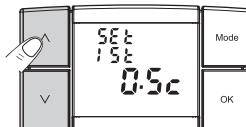

Press the \wedge or \vee key to set the required hysteresis reading.



Press the **OK** key to save and pass on to the subsequent setting or keep pressed for at least 4 seconds to save the new setting and exit program menu.

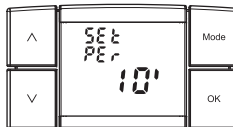

DURATION OF THE PROPORTIONAL CYCLE

The duration of the control cycle for the **PROP** mode can be set from 7 to 20 minutes; a long cycle is advisable for systems with high thermal inertia (cast iron radiators, floor heating systems) and a short cycle for systems with low thermal inertia (fan coil). The default setting is 10 minutes.

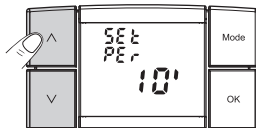

Press the **^** or **v** key to set the duration of the proportional control cycle.

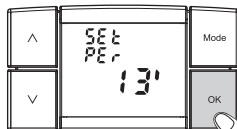

Press the **OK** key to save and pass on to the subsequent setting or keep pressed for at least 4 seconds to save the new setting and exit program menu.

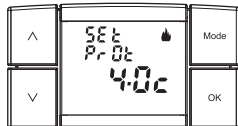

ADJUST OR EXCLUDE ANTIFREEZE PROTECTION

When the thermostat is **OFF**, it is programmed to protect the system in case of frost when the temperature goes below +4.0 °C (+39.2 °F); thus setting is adjustable from +4.0°C to +12.0 °C (+39.2°F ÷ +53.6°F).

It is possible to exclude this function.

In this case the system will be exposed to eventual damage caused by frost.

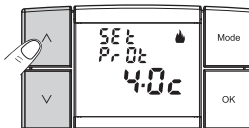

Press the **^** or **v** key to set the required antifreeze temperature reading.



Press the **OK** key to save and return to the °C/°F scale setting or keep pressed for at least 4 seconds to save the new setting and exit program menu.

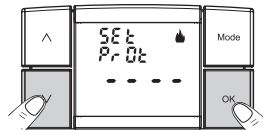

If instead the exclusion of the antifreeze protection is required, press the **v** key until the display shows ---- and confirm by pressing **OK**, as explained above.

EN RESET OPERATION

RESET

Resetting should be done by the installer or expert user as with this operation all the settings and programming previously defined according to the type of installation will be lost.

Once the reset operation is done, the thermostat restores all the default settings provided by the manufacturer.

Press the 4 buttons of the thermostat simultaneously for at least 4 seconds.

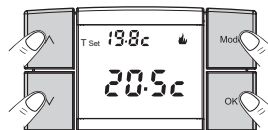

All the display segments switch on for a few seconds.

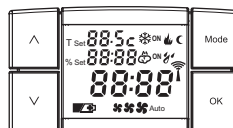

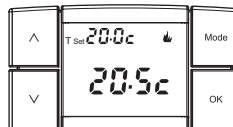

The thermostat resumes its function in Heating mode (Winter) restoring all the default settings provided by the manufacturer.



EVENTUAL FAULTS AND SOLUTIONS

EN

FAULT	CAUSE	SOLUTION
The display of the thermostat is switched off. <i>(3V dc model)</i>	Batteries not fitted Battery polarity error Flat batteries	Check that the batteries have been fitted Check the correct polarity of the batteries Replace batteries
The display of the thermostat is switched off. <i>(230V ac model)</i>	No power supply	Check that the switch or protection differential isn't on OFF
The  symbol on the display start flashing	The batteries are about to run out	Replace the batteries within 30 days
The display shows only the fixed  symbol	The batteries are flat	Replace batteries
The thermostat works but the system is not being activated	There is no power supply to the system The thermostat is not connected properly	Check that the switch or protection differential isn't on OFF Contact the installer
Temperature varies excessively between hot and cold	The thermostat is not correctly set for the type of system	Contact the installer
In the OFF mode, the anti-freeze temperature setting is not displayed	The anti-freeze temperature has been excluded	Set the anti-freeze temperature by following the guidelines given in the PROGRAMMABLE FUNCTIONS chapter

INDEX

DONNES TECHNIQUES	page 39
VUE GÉNÉRALE ET FONCTIONS DES TOUCHES	page 40
INSTALLATION	page 41
MODE D'EMPLOI	page 45
FONCTIONS PROGRAMMABLES D'ADAPTATION AU TYPE D'INSTALLATION	page 48
OPÉRATION DE RÉINITIALISATION	page 54
INCONVÉNIENTS EVENTUELS ET SOLUTIONS	page 55

FRANÇAIS



AVERTISSEMENTS



Lire attentivement le présent manuel avant d'utiliser le produit dans la mesure où il fournit d'importantes indications concernant la sécurité, l'installation et l'utilisation. Conserver soigneusement le manuel pour d'ultérieures consultations.



L'installation et le raccordement électrique du thermostat ne doivent être effectués que par un électricien qualifié et conformément aux normes et aux lois en vigueur.



Avant d'effectuer tout travail sur le dispositif, couper l'alimentation du réseau 230V~.

- Si l'écran affiche une valeur de température ambiante 0 °C ou +37.7 °C (+32 °F ou +99.9 °F) clignotante, cela signifie que la température relevée est hors des limites de la plage de températures.
- Si l'écran affiche "----" clignotant, cela indique qu'une sonde est en panne, toute activité de thermorégulation est alors suspendue.
- **Modèle 3V dc :** utiliser seulement 2 piles alcalines de 1,5V type AAA (LR03), l'emploi de piles non appropriées comporte la possibilité de perte de la programmation configurée.
N.B. : le produit a été testé et il garantit ses caractéristiques avec des piles alcalines DURACELL ou ENERGIZER.
- **Modèle 230V ac :** après avoir installé et configuré le thermostat, en cas d'absence d'alimentation du réseau l'écran s'éteint après avoir sauvegardé toutes les configurations effectuées, au retour de l'alimentation du réseau l'écran s'allume et le dispositif reprend son fonctionnement normal.
- Le cas échéant, nettoyer le thermostat à l'aide d'un chiffon légèrement humide.
- Le fabricant se réserve la faculté d'apporter toutes les modifications techniques et de construction qu'il jugera nécessaires sans obligation de préavis.

DONNÉES TECHNIQUES

FR

Tension d'alimentation : _____ **modèle à piles** 2 x 1,5V piles **Alcalines** type AAA (LR03)
_____ **modèle à tension de réseau** 230V 50÷60Hz

Autonomie modèles à piles : _____ 2 ans environ

Autonomie à partir de l'affichage à l'écran du
symbole clignotant  de piles épuisées : 1 mois environ

Type d'action, déconnexion et appareil : _____ 1/B/ Electronique

Type de sortie : _____ relais avec contact en échange NO / COM / NC sans potentiel
max 5 (3) A / 250V

Logiciel : _____ Classe A

Tension impulsive nominale : _____ 4 kV

Raccordement alimentation de réseau : _____ 2 conducteurs (modèles alimentation 230V~ seulement)

Raccordement dispositif (charge) : _____ 2 ou 3 conducteurs

Section câbles aux bornes : _____ 1,5 mm² ÷ 2,5 mm²

Niveaux de Température : _____ CONFORT et RÉDUCTION NOCTURNE + antigel

Champ d'affichage température ambiante : 0 °C ÷ +37,7 °C / +32 °F ÷ +99,9 °F

Résolution température ambiante : _____ 0,1°C / 0,1°F

Champ de régulation T Set de température : +5 °C ÷ +37,7 °C / +41.0 °F ÷ +99,9 °F (limitable)

Résolution température de réglage : _____ 0,1 °C / 0,1 °F

Température antigel : _____ +4 °C ÷ + 12 °C / 39.2 °F ÷ 53.6 °F (réglable/excluable)

Tolérance sur la lecture de température : _____ ± 0,5 °C / ± 0,9 °F

Type de régulation température :

- ON/OFF avec différentiel _____ configurable de 0,2 °C à 1,2°C / de 0,3 °F à 2,1 °F (défaut 0,5 °C / 0,9 °F)

- Proportionnel avec période de contrôle _____ configurable de 7 à 20 minutes (défaut 10 minutes)

Classification énergétique : _____ ErP: Class I; 1% Reg. EU 811/2013

Gradient thermique : _____ 1°K / 15 min

Degré de protection : _____ IP 30

Classe d'isolement : _____ II 

Degré de pollution : _____ normal

Limites Température de fonctionnement : _____ 0 °C ÷ +50 °C / +32 °F ÷ +122 °F

Limites Température de stockage : _____ -10 °C ÷ +65 °C / +14 °F ÷ +149 °F

Normes de référence pour marquages CE : LVD - EMC EN60730-1 EN60730-2-9

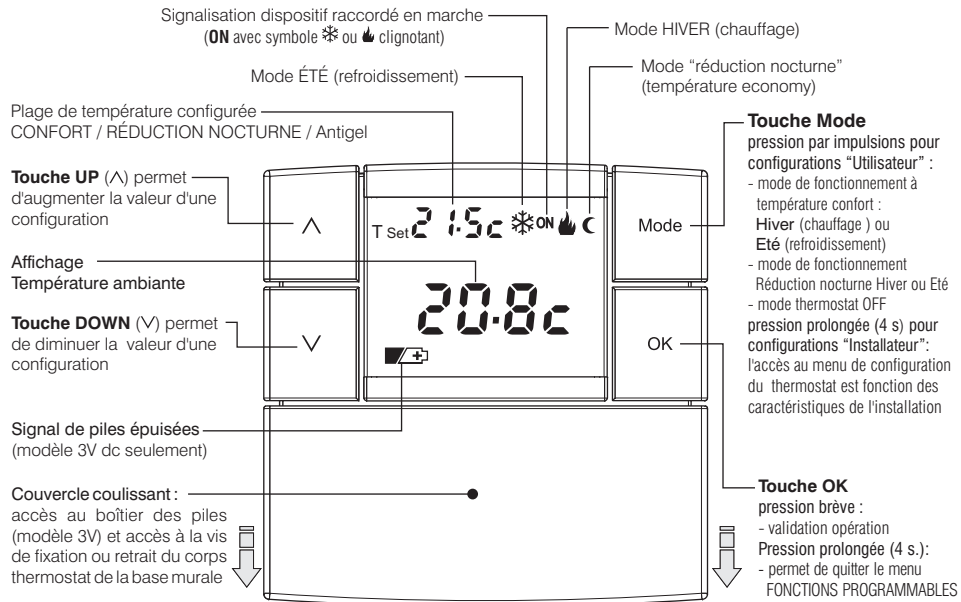

INSTALLATION

FR

EXEMPLE D'INSTALLATION

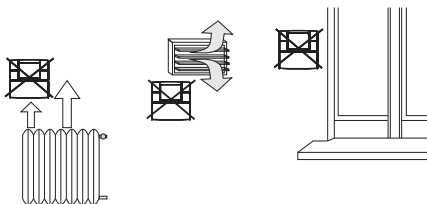
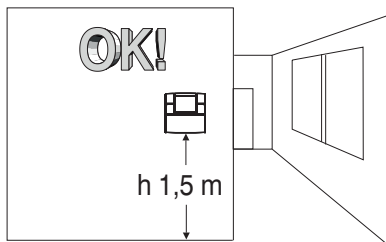

Installer de préférence le thermostat à une hauteur de $1,50 \div 1,60$ m du sol ; loin de sources de chaleur, de prises d'air, de portes ou de fenêtres et de tout ce qui est susceptible d'influencer son fonctionnement.

DIMENSIONS D'ENCOMBREMENT

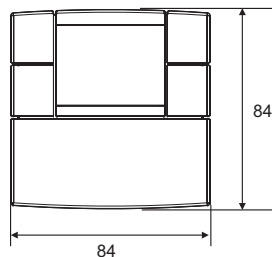

Installation murale

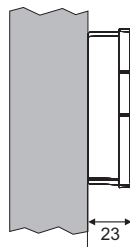

Installation murale
sur boîtier à encastrement rond

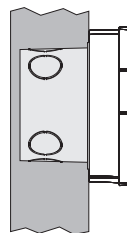

OPÉRATIONS PRÉLIMINAIRES

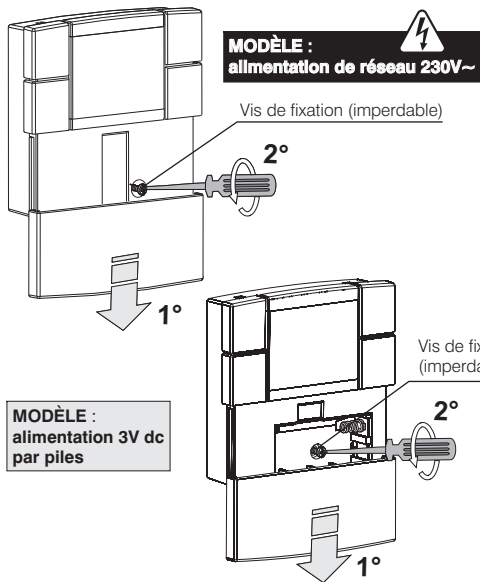

Après avoir dévissé la vis de fixation, séparer la base du thermostat à l'aide d'un tournevis dans la rainure présente au bas du dispositif.

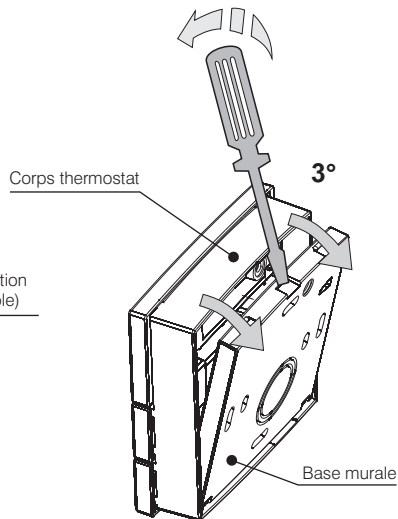

INSTALLATION

FR

BASE MURALE ET BORNES

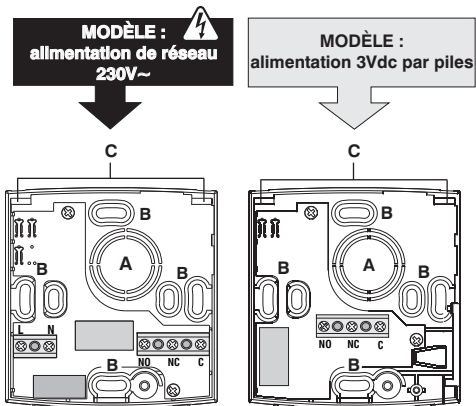

- A - Passage fils par :**
Boîtier encastrable rond ou tuyau ondulé
- B - Trous de fixation de la base :**
muraux ou sur boîtier encastrable rond
- C - Rainures pour fixation thermostat**

RACCORDEMENTS ELECTRIQUES

Couper la tension de réseau 230V~ 
Raccorder l'alimentation de réseau 230V~ aux bornes :

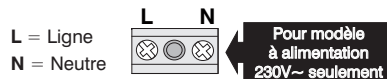

Raccorder le dispositif à commander aux bornes :

- NO** = contact normalement ouvert
- NC** = contact normalement fermé
- C** = commun

Exemples de raccordements électriques

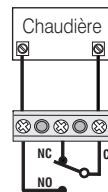

Raccordement à une chaudière

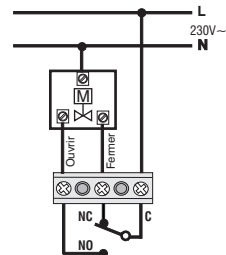

Raccordement à une vanne motorisée

FIXATION ET RETRAIT DU THERMOSTAT

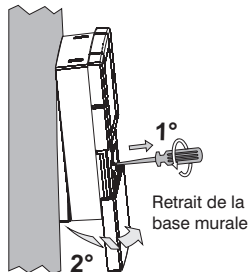
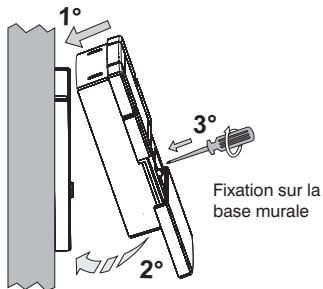

POUR MODÈLE À ALIMENTATION PAR PILES (3Vdc)

INTRODUCTION OU REMPLACEMENT DES PILES

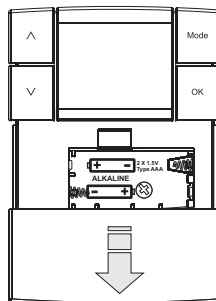

Introduire ou remplacer par 2 piles de 1,5V type AAA - LR03 en faisant attention aux polarités.

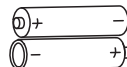

Utiliser des piles alcalines de bonne qualité (Piles conseillées : Duracell ou Energizer).







Traiter les piles usagées en les jetant dans les récipients prévus à cet effet et en tout cas conformément aux prescriptions des normes sur la protection de l'environnement

Attention : la durée des piles peut être supérieure à 2 ans. Il est toutefois conseillé de les remplacer au moins tous les 24 mois pour éviter qu'elles ne s'épuisent pendant les période d'absence (ex. vacances de Noël, etc.)

MODES DE FONCTIONNEMENT

Le thermostat prévoit 5 modes de fonctionnement:

	HIVER = chauffage (configuration d'usine) avec température de CONFORT
	Réduction nocturne hiver = chauffage avec température de RÉDUCTION (économique)
OFF	Thermostat éteint - En fonctionnement <i>chauffage</i> : le mode température antigel est activé (s'il n'a pas été exclu durant la programmation) - En fonctionnement <i>refroidissement</i> : l'installation est complètement désactivé.
	ÉTÉ = refroidissement Avec température de CONFORT
	Réduction nocturne été = refroidissement avec température de RÉDUCTION (économique)

CHANGEMENT MODE DE FONCTIONNEMENT

Changement de température de CONFORT à température de RÉDUCTION et viceversa.

Presser une fois la touche **Mode**, le symbole correspondant et la température programmée clignotent, presser la touche **OK** avant 5 secondes pour confirmer.

Changement de FONCTIONNEMENT NORMAL à OFF

Presser 2 fois la touche **Mode**, l'indication **OFF** et la température antigel programmée clignotent, presser la touche **OK** avant 5 secondes pour confirmer.

Changement d'HIVER à ÉTÉ et viceversa

Presser 3 fois la touche **Mode**, le symbole correspondant et la température programmée clignotent, presser la touche **OK** avant 5 secondes pour confirmer.

Changement de OFF à FONCTIONNEMENT NORMAL

Presser 1 fois la touche **Mode** pour revenir au mode de fonctionnement précédent.

Exemple de fonctionnement:
chauffage activé

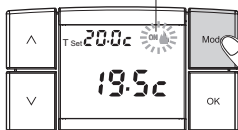

Presser la
touche une
fois **Mode**

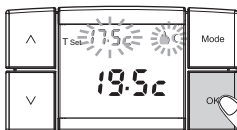

Presser la
Touche **OK**
avant 5 sec.

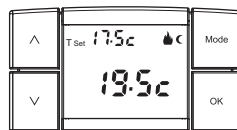

Dans les figures ci-dessus est représenté le passage du mode **HIVER** avec temp. **CONFORT** à la température correspondante de **RÉDUCTION**.

MODIFICATION TEMPÉRATURE T Set CONFIGURÉE

Dans le mode en cours il est possible de modifier la configuration de la température T Set en agissant directement sur les touches \wedge ou \vee , la nouvelle configuration est immédiatement enregistrée.



Remarque : chaque pression des touches \wedge ou \vee comporte la variation de 0,1 degré; en gardant la touche enfoncée on obtient le défilement rapide des valeurs.

Remarque : il est possible de bloquer les réglages de température maximum et minimum (voir chap. FONCTIONS PROGRAMMABLES).

ou :

Appuyer sur une ou plusieurs fois sur la touche **Mode** jusqu'à afficher le mode de fonctionnement souhaité.

Dans les 5 secondes qui suivent,

appuyer sur la touche \wedge pour augmenter la valeur T Set configurée ou sur la touche \vee pour la diminuer.

Remarque : si l'on exclu la température antigel (voir chap. FONCTIONS PROGRAMMABLES), l'utilisateur ne pourra pas modifier le réglage de température antigel configuré.

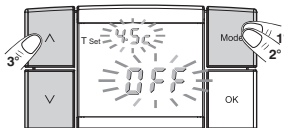





Au bout de 5 secondes après la dernière pression d'une touche le thermostat reprend son fonctionnement précédent.

IMPORTANT: le thermostat permet d'effectuer des configurations de T Set allant de +5 °C à 37,7 °C (+41,0 °F ÷ +99,9 °F) avec des valeurs de température qui satisfont les conditions suivantes :

Hiver : configuration température "Confort" supérieure ou égale à la température de réduction hiver

Été : configuration température de "Confort" inférieure ou égale à la température de "Réduction" été.

Les températures T Set configurées en usine sont les suivantes :

-  **Mode hiver (chauffage):**
 température Confort **20,0 °C / 68,0 °F**
 Chaudière en marche avec température ambiante inférieure à 20,0 °C / 68,0 °F
-  **Réduction nocturne hiver :**
 Température "Réduction" **17,5 °C / 63,5 °F**
 Chaudière en marche avec température ambiante inférieure à 17,5 °C / 63,5 °F
-  **Mode été (refroidissement) :**
 température "Confort" **25,0 °C / 77,0 °F**
 Climatiseur en marche avec température ambiante supérieure à 25,0 °C / 77,0 °F
-  **Réduction nocturne été :**
 température "Réduction" **28,0 °C / 82,4 °F**
 Climatiseur en marche avec température ambiante supérieure à 28,0 °C / 82,4 °F
- OFF Thermostat éteint (mode antigel) :**
 température Antigel **4,0 °C / 39,2 °F** (réglable / excluable)
 - Chaudière en marche avec température ambiante inférieure à 4,0 °C / 39,2 °F
 - Climatiseur désactivé

POUR MODÈLE À ALIMENTATION PAR PILES (3Vdc)

SIGNALISATION PILES PRESQUE ÉPUISÉES

L'affichage du symbole  clignotant indique que les piles sont en train de s'épuiser, à partir de ce moment l'utilisateur a 30 jours de temps environ pour effectuer le remplacement.

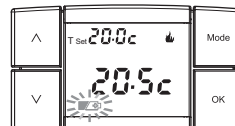

Si les piles presque déchargées ne sont pas remplacées dans les délais préconisés, l'écran s'éteindra, n'affichant que le symbole  fixe.

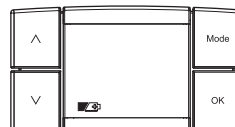

Toute activité de thermostatisation est suspendue et toutes les configurations sont enregistrées pour être rétablies dès l'introduction de piles neuves.

POUR MODÈLE À ALIMENTATION 230V ac SEULEMENT

ABSENCE DE TENSION DE RÉSEAU

En cas d'absence d'alimentation du réseau, l'écran du thermostat s'éteint complètement, le dispositif désactive la thermostatisation et enregistre toutes les configurations effectuées dans une mémoire spéciale, dès le retour de l'alimentation de réseau l'écran s'allume et le dispositif reprend son fonctionnement normal.

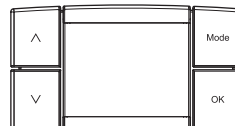

ACCÈS A LA PROGRAMMATION

L'accès à la programmation est réservé à l'installateur ou à des utilisateurs experts dans la mesure où la modification de certaines configurations pourrait compromettre le bon fonctionnement de l'installation.

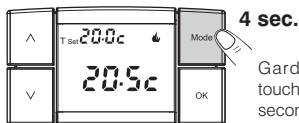

Garder enfoncée la touche **Mode** pendant 4 secondes.

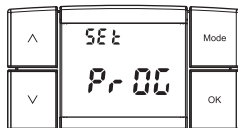

L'écran affiche pendant quelques instants le message SET PROG.

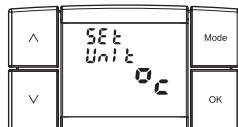

Ensuite le thermostat affiche la page de configuration de l'unité de mesure.

Dans le menu de programmation il est possible de passer d'une fonction à l'autre en appuyant par impulsions sur la touche **Mode**. Ces fonctions sont les suivantes :

- Configuration de l'échelle des températures (°C ou °F)
- Correction de la température ambiante mesurée (OFFSET)
- Verrouillages des Sets de température
- Sélection du mode de régulation de la température : (DIFFÉRENTIEL ON/OFF ou PROPORTIONNEL)
- Modification de la valeur d'hystérèse configurée (Différentiel On/off)
- Modification du cycle de durée configuré (Proportionnel)
- Exclusion ou configuration température antigel

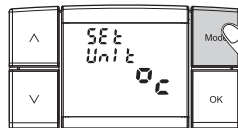

Appuyer sur la touche **Mode** plusieurs fois pour passer d'une fonction à l'autre.

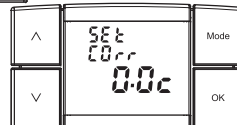

IMPORTANT : pour sortir du menu de programmation incluant les éventuels nouveaux réglages en confirmant avec la touche OK, suivre les instructions suivantes :

Appuyer pendant 4 secondes la touche OK, ou bien attendre 60 secondes (time-out) ; le thermostat revient à son fonctionnement normal.

CONFIGURATION DE L'ECHELLE DES TEMPÉRATURES

Le thermostat est configuré en usine pour l'affichage des températures en degrés Centigrades (Celsius). Pour passer à l'échelle Fahrenheit ou vice versa, procéder comme suit :

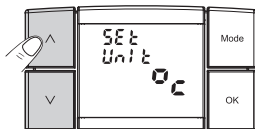

Appuyer sur la touche \wedge ou \vee pour modifier la configuration actuelle.



Appuyer sur la touche **OK** pour enregistrer et passer à la configuration suivante ou la garder enfoncée pendant 4 secondes minimum pour enregistrer la nouvelle configuration puis quitter le menu de programmation.

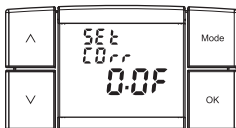

CORRECTION LECTURE DE LA TEMPÉRATURE AMBIANTE

Si pour une raison quelconque le thermostat doit être installé dans une position susceptible d'influencer la température mesurée (ex. mur périmétrique qui est en hiver moyennement plus froid que le reste du logement), il est possible de configurer un Offset (valeur de correction) de la température mesurée, la correction est configurable de -2°C à $+2^{\circ}\text{C}$ ou de -3.6 à $+3.6^{\circ}\text{F}$.

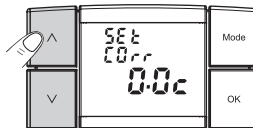

Appuyer sur la touche \wedge ou \vee pour modifier la configuration actuelle.



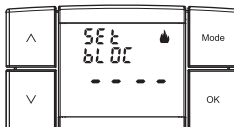

Appuyer sur la touche **OK** pour enregistrer et passer à la configuration suivante ou la garder enfoncée pendant 4 secondes minimum pour enregistrer la nouvelle configuration puis quitter le menu de programmation.



VERROUILLAGE SET DE TEMPÉRATURE MAX (hiver) et MIN (été)

Dans certains cas particuliers d'installation du thermostat, par exemple dans des locaux publics, des hôtels, etc., il pourrait être utile de limiter le set de température Confort de manière à éviter des configurations incorrectes par un personnel non autorisé.

Il sera donc possible de limiter les valeurs de Set température maximum si le thermostat est en mode  Hiver (chauffage), ou de limiter les valeurs de Set température minimum si le thermostat est en mode  Été (refroidissement).

La configuration de base ne prévoit aucun verrouillage.

Exemple : verrouillage du set de température Confort maximum pour le mode Hiver (chauffage)

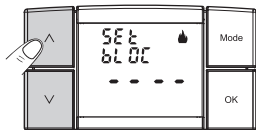

A l'aide des touches \wedge ou \vee configurer la valeur de verrouillage de la température maximum.

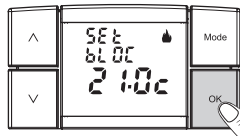

Appuyer sur la touche **OK** pour enregistrer et passer à la configuration du verrouillage pour le  Refroidissement ou la garder enfoncée pendant 4 s minimum pour enregistrer la nouvelle configuration puis quitter le menu de programmation.

Exemple : verrouillage du set de température Confort minimum pour le mode Été (refroidissement)

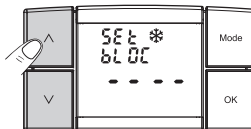

A l'aide des touches \wedge ou \vee configurer la valeur de verrouillage de la température minimum.



Appuyer sur la touche **OK** pour enregistrer et passer à la configuration suivante ou la garder enfoncée pendant 4 s minimum pour enregistrer la nouvelle configuration puis quitter le menu de programmation.

Remarque : pour annuler des verrouillages éventuels précédemment configurés, remettre les set sur - - - -

MODES DE RÉGULATION DE LA TEMPÉRATURE

Le thermostat fonctionne (configuration d'usine) en mode **Différentiel ON/OFF** avec la valeur du différentiel thermique (**Hystérèse**) fixé à **0,5 °C** (configurable de 0,2 °C à 1,2 °C).

La valeur de l'Hystérèse doit être configurée en fonction de l'inertie thermique de l'installation, il est conseillé de fixer une valeur basse pour les installations avec radiateurs (ex. en fonte) et une valeur élevée pour les installations avec ventilo-convecteurs.

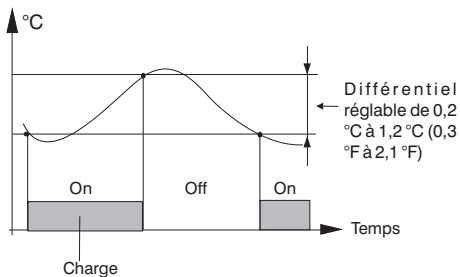

En alternative au différentiel, il est possible de régler la température de façon **PROPORTIONNELLE (PROP)** avec période de contrôle configurable de 7 à 20 minutes (défaut 10 minutes); ce système permet de maintenir la température souhaitée plus stable, en augmentant la sensation de confort pour l'utilisateur et en économisant sur les consommations d'énergie.

Exemple de configuration: t set = 20 °C - Cycle = 10 min

t	Dispositif toujours éteint	°C
t = 20,5 °C	Dispositif toujours éteint	20,8
t = 20,4 °C	Dispositif 1 min ON - 9 min OFF	20,6
t = 20,3 °C	Dispositif 2 min ON - 8 min OFF	20,4
t = 20,2 °C	Dispositif 3 min ON - 7 min OFF	20,2
t = 20,1 °C	Dispositif 4 min ON - 6 min OFF	20,0
t = 20,0 °C	Dispositif 5 min ON - 5 min OFF	19,8
t = 19,9 °C	Dispositif 6 min ON - 4 min OFF	19,6
t = 19,8 °C	Dispositif 7 min ON - 3 min OFF	19,4
t = 19,7 °C	Dispositif 8 min ON - 2 min OFF	19,2
t = 19,6 °C	Dispositif 9 min ON - 1 min OFF	
t = 19,5 °C	Dispositif toujours allumé	

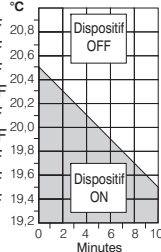

Il est conseillé de configurer un cycle long pour les installations à haute inertie thermique (radiateurs en fonte, installations radiantés au sol) et un cycle court pour les installations à basse inertie thermique (ventilo-convecteurs).

Choisir le mode de régulation de la température et configurer les valeurs correspondantes selon les caractéristiques de votre installation comme il est indiqué aux paragraphes suivants.

SÉLECTION DU MODE DE RÉGULATION DE LA TEMPÉRATURE (DIFFÉRENTIEL ON/OFF ou PROPORTIONNEL)

Cette procédure permet de sélectionner le mode de régulation de la température entre fonctionnement Différentiel ON:OFF (configuration d'usine) et Proportionnel PROP.

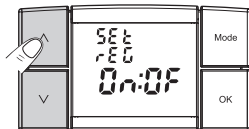

A l'aide des touches \wedge ou \vee configurer le mode de régulation de la température souhaitée.

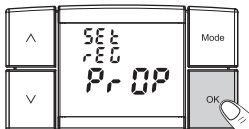

Appuyer sur la touche **OK** pour enregistrer et passer à la configuration suivante ou la garder enfoncée pendant 4 s minimum pour enregistrer la nouvelle configuration puis quitter le menu de programmation.

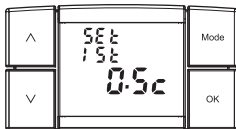

CONFIGURATION DE L'HYSTERESE

La valeur de l'Hystérèse pour le mode de régulation ON:OFF doit être configurée en fonction de l'inertie thermique de l'installation, il est conseillé de fixer une valeur basse pour les installations avec radiateurs (ex. en fonte) et une valeur élevée pour les installations avec ventilo-convecteurs. La valeur est configurable de 0,2 °C à 1,2 °C (0,3 °F à 2,1 °F) ; la configuration d'usine est de 0,5 °C (0,9 °F).

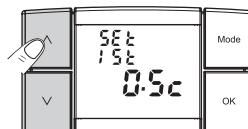

A l'aide des touches \wedge ou \vee configurer la valeur de l'hystérèse.



Appuyer sur la touche **OK** pour enregistrer et passer à la configuration suivante ou la garder enfoncée pendant 4 s minimum pour enregistrer la nouvelle configuration puis quitter le menu de programmation.

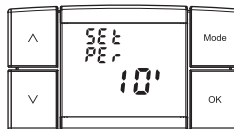

DURÉE DU CYCLE PROPORTIONNEL

La durée du cycle de contrôle pour le fonctionnement en mode **PROP** est configurable de **7 à 20 minutes** ; Il est conseillé de configurer un cycle long pour les installations à haute inertie thermique (radiateurs en fonte, installations radiantes au sol) et un cycle court pour les installations à basse inertie thermique (ventilo-convecteurs). La configuration d'usine est de **10 minutes**.

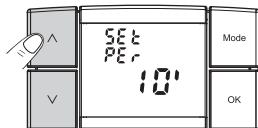

A l'aide des touches **^** ou **V** configurer la durée du cycle de contrôle proportionnel.

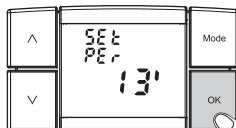

Appuyer sur la touche **OK** pour enregistrer et passer à la configuration suivante ou la garder enfoncée pendant 4 sec. minimum pour enregistrer la nouvelle configuration puis quitter le menu de programmation.

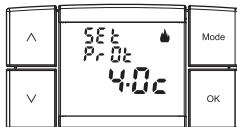

RÉGULATION OU EXCLUSION DE LA PROTECTION ANTIGEL

En mode de fonctionnement **OFF**, le thermostat est programmé pour protéger l'installation en cas de gel quand la température descend en dessous de **+4.0°C (+39.2°F)** ; cette configuration est réglable de **+4.0°C à +12.0°C (+39.2°F ÷ +53.6°F)**. Il est possible d'exclure cette fonction. Dans ce cas l'installation sera exposée à des dommages éventuels causés par le gel.

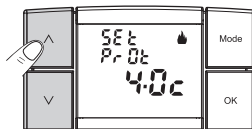

A l'aide des **^** ou **V** configurer la valeur de température antigel souhaitée.

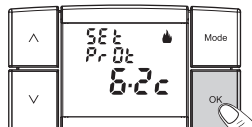

Appuyer sur la touche **OK** pour enregistrer et passer à la configuration suivante ou la garder enfoncée pendant 4 s minimum pour enregistrer la nouvelle configuration puis quitter le menu de programmation.

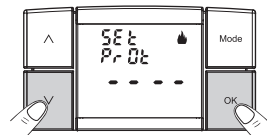

En revanche si l'on souhaite exclure la protection antigel, appuyer sur la touche **V** jusqu'à afficher à l'écran **---** et valider en appuyant sur le bouton **OK**, comme décrit ci-dessus.

RÉINITIALISATION

L'opération de Réinitialisation est conseillée à l'installateur ou aux utilisateurs experts dans la mesure où cette opération implique la perte de toutes les configurations et des programmations précédemment exécutées selon le type d'installation. Une fois que l'opération de Réinitialisation est terminée, le thermostat rétablit toutes les configurations d'usine.

Appuyer simultanément sur les 4 touches du thermostat et les garder enfoncées pendant 4 secondes minimum.

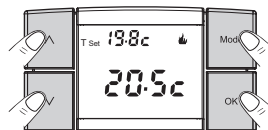

Tous les tirets de l'écran s'allument pendant quelques instants.

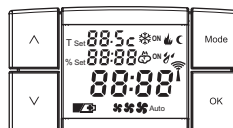

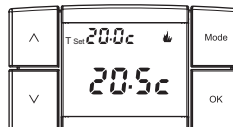

Le thermostat reprend le fonctionnement en mode Chauffage (hiver) et rétablit toutes les configurations d'usine.



INCONVÉNIENTS EVENTUELS ET SOLUTIONS

FR

INCONVÉNIENT	CAUSE	SOLUTION
L'écran du thermostat est éteint (Modèle 3Vdc)	Piles non installées Polarité des piles incorrecte Pile Piles épuisées	Contrôler si les piles sont installées Vérifier la polarité des piles Remplacer les piles
L'écran du thermostat est éteint (Modèle 230V ac)	Absence de tension de réseau	Contrôler si l'interrupteur ou le différentiel de protection n'est pas sur OFF
L'écran affiche le symbole  clignotant	Les piles sont sur le point de se décharger	Remplacer les piles dans les 30 jours
L'écran n'affiche que le symbole  fixe	Les piles sont épuisées	Remplacer les piles
Le thermostat fonctionne mais l'installation n'est pas activée	Absence de tension de l'installation Le thermostat n'est pas raccordé correctement	Contrôler si l'interrupteur ou le différentiel de protection n'est pas sur OFF Contacter l'installateur
La température oscille trop entre chaud et froid	Le thermostat n'est pas configuré de manière correcte pour le type d'installation	Contacter l'installateur
En fonctionnement OFF le réglage de température antigel ne s'affiche pas	La température antigel a été exclue	Configurer la température antigel en suivant les indications reportées au chap. FONCTIONS PROGRAMMABLES

INHALTSVERZEICHNIS

TECHNISCHE DATEN	Seite 57
GESAMTANSICHT UND TASTENFUNKTION	Seite 58
INSTALLATION	Seite 59
BEDIENUNGSANLEITUNG	Seite 63
PROGRAMMIERBARE FUNKTIONEN ZUR ANPASSUNG AN DIE ANLAGEART	Seite 66
RÜCKSETZUNGSFUNKTION	Seite 72
EVENTUELLE STÖRUNGEN UND PROBLEMLÖSUNGEN	Seite 73

DEUTSCH



GEBRAUCHSANWEISUNG



Lesen Sie aufmerksam die vorliegende Beschreibung bevor Sie das Produkt verwenden, da diese wichtige Informationen zu Sicherheit, Installation den Gebrauch enthält. Bewahren Sie die Gebrauchsanweisung sorgfältig zum zukünftigen Nachschlagen auf.



Die Installation und der elektrische Anschluss des Thermostats müssen nur von Elektrofachkraft und in Übereinstimmung mit den geltenden Vorschriften und gesetzlichen Bestimmungen vorgenommen werden.



Vor der Ausführung jeglicher Arbeiten am Gerät ist die Netzversorgung 230 V~ zu unterbrechen

- Wenn auf dem Display die Raumtemperatur $0\text{ }^{\circ}\text{C}$ o $+37.7\text{ }^{\circ}\text{C}$ ($+32\text{ }^{\circ}\text{F}$ o $+99.9\text{ }^{\circ}\text{F}$) aufblinkt, bedeutet dies, dass die gemessene Temperatur über dem Grenzwert liegt.
- Wenn auf dem Display dieses Zeichen aufblinkt "- - -" bedeutet dies, dass der Sensor ausgefallen ist und jegliche Temperaturregelung abgebrochen wird.
- **Modell mit 3V dc:** verwenden Sie ausschließlich 2 Batterien 1,5V vom Typ AAA (LR03), der Gebrauch von ungeeigneten Batterien könnte einen Verlust der Programmierung zur Folge haben.
Beachten Sie.: das Produkt wurde mit Alkalibatterien von DURACELL oder ENERGIZER getestet und garantiert mit diesen seine volle Funktion.
- **Modell mit 230V ac:** nachdem Sie das Thermostat installiert und eingestellt haben, werden im Falle eines Stromausfalls das Display ausgeschaltet und alle Einstellungen gespeichert, wobei nach erneutem Einschalten das Display normal funktioniert.
- Falls nötig, reinigen Sie das Thermostat mit einem feuchteten Tuch.
- Der Hersteller behält sich vor jede für nötig empfundene technische und herstellungstechnische Änderung vorzunehmen, auch ohne vorangehende Ankündigung.

TECHNISCHE DATEN

DE

Versorgungsspannung: _____	Modell mit Batteriebetrieb 2 x 1,5V Alkalibatterien Typ AAA (LR03)
	Modell mit Stromanschluss 230V 50÷60Hz
Betriebsdauer der Modelle mit Batteriebetrieb: _____	ungefähr 2 Jahre
Betriebsdauer nach Aufleuchten von [] _____	
"Batterien erschöpft" auf Display: _____	Ungefähr 1 Monat
Betriebsart, Abschaltung und Gerätetyp: _____	1/B/ Elektronisch
Ausgang: _____	Relais mit unipolarem Weichenkontakt NO / COM / NC potentialfrei -max 5 (3) A / 250V
Software: _____	Klasse A
Nenn-Impulsspannung: _____	4 kV
Netzanschluss: _____	2 Stromleitungen (nur mit 230V~ gespeiste Modelle)
Verbindungsabnahme (elektrische Last) _____	2 oder 3 Stromleitungen
Kabelquerschnitt an den Eingangsklemmen: _____	1,5 mm ² ÷ 2,5 mm ²
Temperaturniveaus: _____	KOMFORT und NÄCHTLICHE TEMPERATURABNAHME + Frostschutz
Temperaturanzeigebereich: _____	0 °C ÷ +37,7 °C / +32 °F ÷ +99,9 °F
Auflösung Raumtemperatur: _____	0,1°C / 0,1°F
Temperatur Regelbereich: _____	+5 °C ÷ +37,7 °C / +41.0 °F ÷ +99,9 °F (beschränkbar)
Auflösung Solltemperatur: _____	0,1 °C / 0,1 °F
Frostschutztemperatur: _____	+4 °C ÷ + 12 °C / 39.2 °F ÷ 53.6 °F (Regulierbare/ausschließbare)
Toleranz in der Temperatur ablesung: _____	± 0,5 °C / ± 0,9 °F
Arten der Temperaturregelung:	
- ON / OFF mit einstellbarem Differenzial _____	von 0,2 °C bis 1,2°C / von 0,3 °F bis 2,1 °F (Standard 0,5 °C / 0,9 °F)
- Proportional zur Kontrolldauer _____	einstellbar von 7 bis 20 Minuten (Standard 10 Minuten)
Energie-Klassifizierung: _____	ErP: Class I; 1% Reg. EU 811/2013
Temperaturgradient: _____	1°K / 15 min
Schutzgrad: _____	IP 30
Isolationsklasse: _____	II <input type="checkbox"/>
Verschmutzungsgrad: _____	Normal
Betriebstemperaturbereich: _____	0 °C ÷ +50 °C / +32 °F ÷ +122 °F
Lagerungstemperaturbereich: _____	-10 °C ÷ +65 °C / +14 °F ÷ +149 °F
Referenznormen für CE Zeichen: _____	LVD - EMC EN60730-1 EN60730-2-9

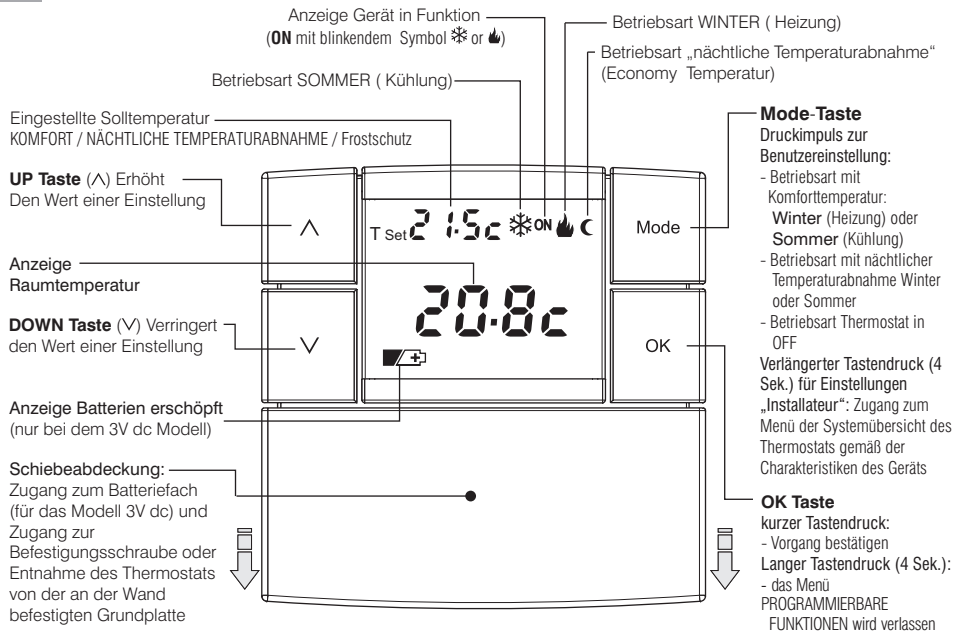

INSTALLATIONSBEISPIEL

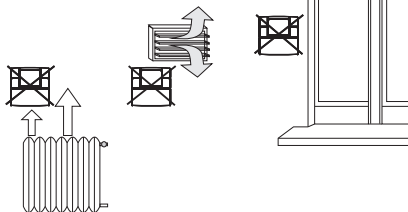
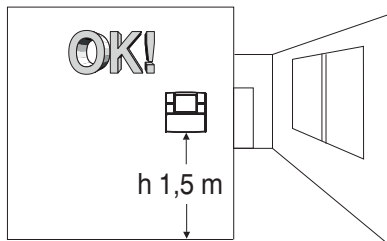

Installation des Thermostats bevorzugt in einer Höhe von 1,50 bis 1,70 m vom Boden, fern von Wärmequellen, Luftzügen, Türen oder Fenstern und anderen Dingen, die den Betrieb stören könnten.

ABMESSUNGEN

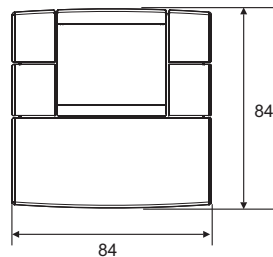

Einbau in die Wand

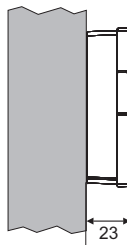

Einbau in die Wand auf runder Einputzdose

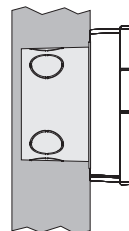

VORBEREITUNGEN

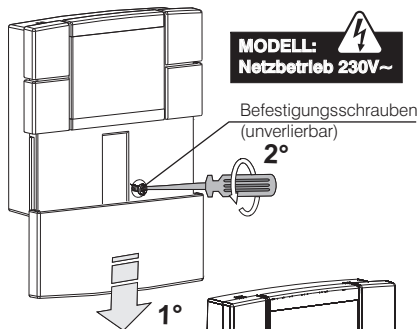

**MODELL:
Batteriebetrieb
mit 3V dc Batterien**

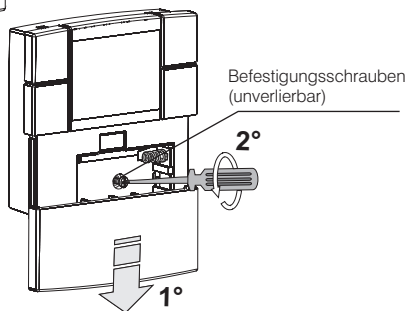

Nach dem Herausschrauben der Befestigungsschrauben, die Grundplatte vom Thermostat mit Hilfe eines Schraubenziehers abheben, welcher in die auf der Unterseite dafür vorgesehene Einkerung gesteckt wird.

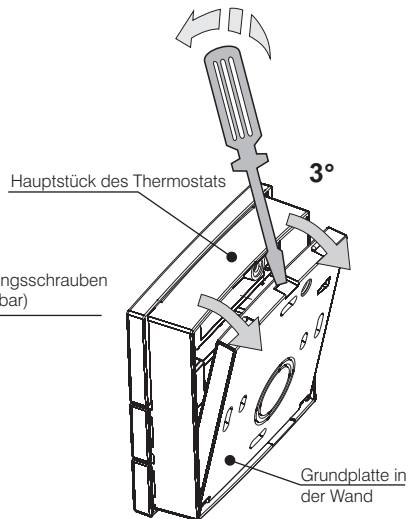

INSTALLATION

DE

GRUNDPLATTE UND ANSCHLUSSKLEMMEN

MODELL: 
Netzbetrieb 230V~

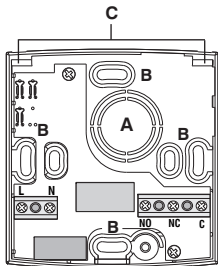

A - Durchgang der Leitungen von:

Runder Einputzdose oder Faltschlauch

B - Befestigungslöcher der Grundplatte:

In der Wand oder in der runden Einputzdose

C - Aussparungen zum Anbringen des Thermostats

MODELL:
Batteriebetrieb mit 3V dc
Batterien

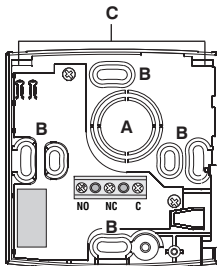

ELEKTRISCHE ANSCHLÜSSE

Netzstrom von 230V~ unterbrechen 

Netzstrom von 230V~ mit Anschlussklemmen verbinden:

L = Linie
N = Neutral



**Nur für das Modell mit
230 V~ Speisung**

Die zu steuernde Einrichtung mit den
Anschlussklemmen verbinden:

NO = normaler offener Kontakt

NC = normaler geschlossener Kontakt

C = gemeinsam

Beispiele für elektrische Anschlüsse

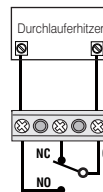

Anschluss an einen
Durchlauferhitzer

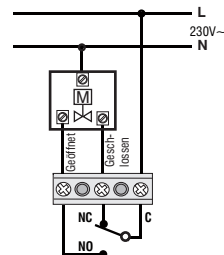

Anschluss an ein
motorisiertes Ventil

BEFESTIGUNG ODER ENTFERNUNG DES THERMOSTATS

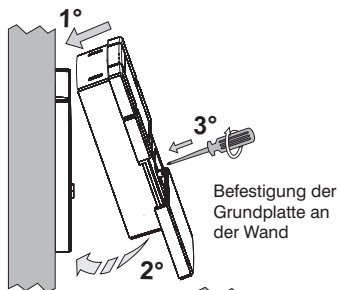

Befestigung der Grundplatte an der Wand

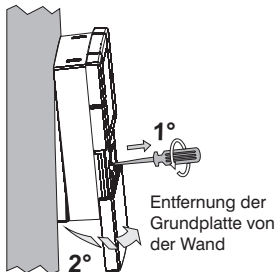

Entfernung der Grundplatte von der Wand

NUR MODELL MIT BATTERIEBETRIEB (3Vdc)

EINLEGEN ODER ERSETZEN DER BATTERIEN

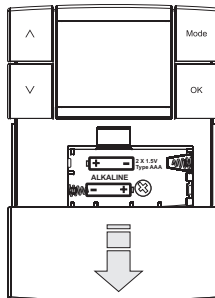

Einsetzen oder Ersetzen von zwei Alkalibatterien vom Typ AAA LR03, dabei die korrekte Polung beachten.

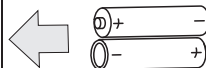

Alkalibatterien guter Qualität verwenden (Es werden *Duracell* oder *Energizer Batterien* empfohlen).





Die leeren Batterien in die hierfür vorgesehenen Sammelbehälter werfen und auf jeden Fall gemäß den Umweltvorschriften entsorgen.

Achtung: die Lebensdauer der Batterien kann auch mehr als 2 Jahre betragen. Es wird dennoch empfohlen, sie mindestens alle 24 Monate auszuwechseln, um zu vermeiden, dass sie sich während der Abwesenheitsphasen (beispielsweise während der Weihnachtsferien usw.) Entleeren.

BETRIEBSMODUS

Das Thermostat verfügt über die folgenden 5 Betriebsmodi:

	WINTER = Heizung (Werkseinstellung) mit KOMFORT -Temperatur
	Nächtliche Temperaturabnahme Winter = Heizung mit TEMPERATURABNAHME (Einsparung)
OFF	Thermostat ausgeschaltet - <i>Im Betriebsmodus Heizung:</i> Frostschutzmodus ist aktiv (wenn nicht bei der Programmierung deaktiviert) - <i>Im Betriebsmodus Kühlung:</i> die Anlage ist vollständig deaktiviert
	SOMMER = Kühlung mit KOMFORT -Temperatur
	Nächtl. Temperaturabnahme Sommer = Kühlung Mit TEMPERATURABNAHME (Einsparung)

Beispiel: Betriebsmodus Heizung aktiv

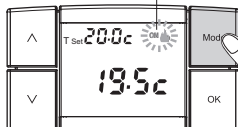

Einmal die **Mode**-Taste Drücken

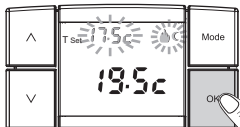

Innerhalb von 5 Sek. die **OK**-Taste drücken

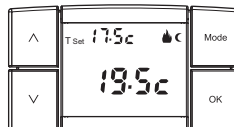

WECHSEL DES BETRIEBSMODUS

Wechsel von **KOMFORT-TEMPERATUR** zu **TEMPERATURABNAHME** und umgekehrt

Einmal die **Mode**-Taste drücken, das zugehörige Symbol und die eingestellte Temperatur blinken, zur Bestätigung innerhalb von 5 Sekunden die **OK**-Taste drücken.

Wechsel von **NORMALBETRIEB** zu **OFF**

2 mal die **Mode**-Taste drücken, die Schrift **OFF** und die Frostschutztemperatur blinken, zur Bestätigung innerhalb von 5 Sekunden die **OK**-Taste drücken.

Wechsel von **WINTER** zu **SOMMER** und umgekehrt

3 mal die **Mode**-Taste drücken, das zugehörige Symbol und die eingestellte Temperatur blinken, zur Bestätigung innerhalb von 5 Sekunden die **OK**-Taste drücken.

Wechsel von **OFF** zu **NORMALBETRIEB**

1 mal die **Mode**-Taste drücken um zum vorherigen Betriebsmodus zurückzukehren.

In der obenstehenden Abbildung wird der Übergang vom Modus **WINTER** mit **KOMFORT**-Temperatur zur entsprechenden **TEMPERATURABNAHME** dargestellt.

ÄNDERUNG DER EINGESTELLTEN TEMPERATUR T Set

Vom laufenden Modus aus ist es möglich die T Set Temperatureinstellungen direkt mit den Tasten \wedge oder \vee , zu ändern, die neue Einstellung wird sofort gespeichert.

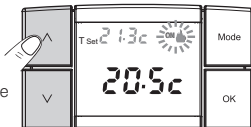

Anmerkung: jeder Tastendruck \wedge oder \vee bringt eine Temperaturveränderung von 0,1 Grad mit sich, der verlängerte Tastendruck bringt einen schnellen Durchlauf der Werte mit sich.

Anmerkung: die Höchst- und Mindesttemperatur-Sets können blockiert werden (siehe Kap. PROGRAMMIERBARE FUNKTIONEN).

Oder auch:

Einmaliges oder mehrmaliges Drücken der **Mode**-Taste, bis der gewünschte Betriebsmodus angezeigt wird.

Innerhalb von 5 Sekunden,

Die \wedge -Taste drücken um den eingestellten T Set Wert zu erhöhen oder die \vee -Taste um ihn zu verringern.

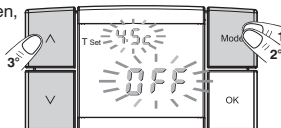

Sobald seit dem letzten Tastendruck 5 Sekunden vergangen sind, nimmt das Thermostat seine vorrangegangene Tätigkeit wieder auf.

Anmerkung: falls das Frostschutztemperatur-Programm ausgeschlossen wurde (siehe Kap. PROGRAMMIERBARE FUNKTIONEN), kann der Benutzer die eingestellte Frostschutz Set-Temperatur nicht verändern.

WICHTIG: das Thermostat sieht T Set Einstellungen von +5 °C bis 37,7 °C (+41,0 °F ÷ +99,9 °F) vor, mit Temperaturwerten, die die folgenden Bedingungen erfüllen:
Winter: Einstellung der "Komforttemperatur" größer oder gleich der "Abnahmetemperatur" Winter.
Sommer: Einstellung der "Komforttemperatur" geringer oder gleich der "Abnahmetemperatur" Sommer.

Die Werkeinstellungen der Temperaturen T Set sind die folgenden:

🔥	Wintermodus (Heizung): Komforttemperatur 20,0 °C / 68,0 °F Durchlauferhitzer in Funktion bei einer Raumtemperatur unter 20,0 °C / 68,0 °F
🔥☾	Nächtliche Temperaturabnahme Winter: Temperatur „Abnahme“ 17,5 °C / 63,5 °F Durchlauferhitzer in Funktion bei einer Raumtemperatur unter 17,5 °C / 63,5 °F
❄️	Sommermodus (Kühlung): Komforttemperatur 25,0 °C / 77,0 °F Klimaanlage in Funktion bei einer Raumtemperatur über 25,0 °C / 77,0 °F
❄️☾	Nächtliche Temperaturabnahme Sommer: Temperatur „Abnahme“ 28,0 °C / 82,4 °F Klimaanlage in Funktion bei einer Raumtemperatur über 28,0 °C / 82,4 °F
OFF	Thermostat ausgeschaltet (Frostschutzmodus): Frostschutztemperatur 4,0 °C / 39,2 °F (regulierbar oder ausschließbar) - Durchlauferhitzer in Funktion bei einer Raumtemperatur unter 4,0 °C / 39,2 °F - Klimaanlage deaktiviert

BEDIENUNGSANLEITUNG

DE

NUR MODELL MIT BATTERIEBETRIEB (3Vdc)

ANZEIGE BATTERIEN SCHWACH ODER ERSCHÖPFT

Das Auftreten des blinkenden  Symbols, deutet darauf hin, dass die Batterien schwächer werden, von diesem Moment an stehen etwa 30 Tage zum Auswechseln zur Verfügung.

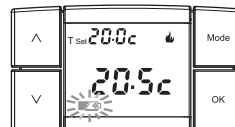

Wenn in dieser Zeit die fast leeren Batterien nicht ausgewechselt wurden, wird das Display ausgeschaltet und zeigt **andauernd** das  Symbol an.

Jegliche Temperaturregelung wird unterbrochen und alle Einstellungen werden gespeichert, um beim Einsetzen der neuen Batterien abrufbereit zu sein.

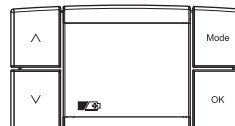

NUR BEI DEM MODELL MIT 230V ac VERSORGUNG

FEHLENDER STROMFLUSS

Im Falle eines Stromausfalls wird das Display des Thermostats komplett ausgeschaltet, und die Temperaturregelung deaktiviert. Alle ausgeführten Einstellungen werden in einem speziellen Datenspeicher gesichert. Bei erneuter Stromzufuhr geht das Display an und funktioniert normal weiter.

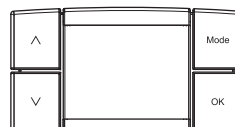

ZUGANG ZUR PROGRAMMIERUNG

Der Zugang zur Programmierung wird dem **Installateur und erfahrenen Anwendern** geraten, da die Änderung einiger Einstellungen die korrekte Funktionstüchtigkeit des Geräts beeinträchtigen könnten.

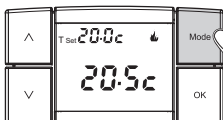

4 Sek.

Die **Mode** Taste 4 Sekunden lang gedrückt halten.

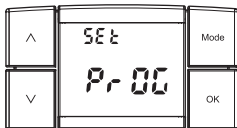

Auf dem Display erscheint für wenige Augenblicke der Schriftzug **SET PROG.**

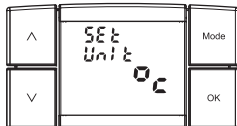

Daraufhin zeigt das Thermostat die Seite der Einstellung der Maßeinheit an.

Innerhalb des Programmiermenüs wechselt man von einer Funktion zur nächsten indem man die **Mode** - Taste drückt. Die Funktionen sind, der Reihe nach, die Folgenden:

- Einstellung der Temperaturskala (°C oder °F)
- Berichtigung der gemessenen Raumtemperatur (OFFSET)
- Datenblöcke der Temperatur Sets
- Auswahl der Regulierungsmodi der Temperatur: (DIFFERENZIAL ON / OFF oder PROPORTIONAL)
- Änderung des eingestellten Hysterese werts (Differenzial on/off)
- Änderung der eingestellten Zyklusdauer (Proportional)
- Ausschließung oder Einstellung der Frostschutztemperatur

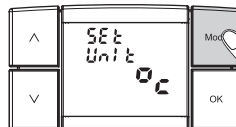

Die **Mode** Taste mehrmals drücken, um von einer Funktion zur anderen zu gelangen.

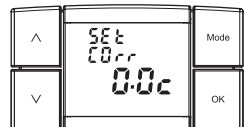

WICHTIG: um das Programmiermenü zu verlassen und dabei die mit der OK-Taste bestätigten eventuellen neuen Einstellungen einzuschließen, wie folgt verfahren:

4 Sekunden lang die OK-Taste drücken oder 60 Sekunden warten (time-out); das Thermostat kehrt in den Normalbetrieb zurück.

EINSTELLUNGEN DER TEMPERATURSKALEN

Die Werkeinstellungen des Thermostats der Temperatur sind in Grad Celsius, es ist möglich mit dem folgenden Verfahren zur Fahrenheitskala oder umgekehrt zu wechseln:

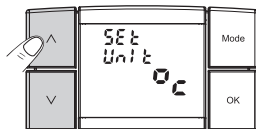

Drücken der \wedge -Taste oder der \vee -Taste, um die aktuellen Einstellungen zu ändern.

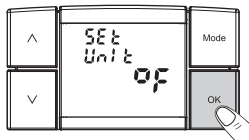

Die **OK**-Taste drücken, um die Einstellung zu speichern und zur nächsten Einstellung zu gelangen oder mindestens 4 Sek. gedrückt halten, um die neue Einstellung zu speichern und das Programmiermenü zu verlassen.

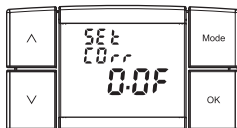

BERICHTIGUNG DER GEMESSENEN RAUMTEMPERATUR

Falls aus irgendeinem Grund das Thermostat in einer Position installiert wird, in der die gemessene Temperatur beeinflusst werden könnte (z.B.: die Außenwand, die im Winter im Durchschnitt kühler ist als der Rest der Wohnung) so kann man ein Offset der gemessenen Temperatur vornehmen (Korrektionswert). Die Korrektur ist von $-2\text{ }^{\circ}\text{C}$ bis $+2\text{ }^{\circ}\text{C}$ oder von -3.6 bis $+3.6\text{ }^{\circ}\text{F}$ einstellbar.

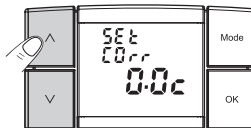

Die \wedge -Taste oder die \vee -Taste drücken, um die aktuelle Einstellung zu ändern.



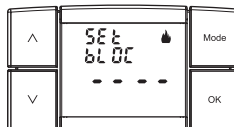

Die **OK**-Taste drücken, um die Einstellung zu speichern und zur nächsten Einstellung zu gelangen oder mindestens 4 Sek. gedrückt halten, um die neue Einstellung zu speichern und das Programmiermenü zu verlassen.



DATENBLÖCKE DER TEMPERATUR SETS MAX (Winter) und MIN (Sommer)

In besonderen Fällen der Installation des Thermostats, z.B.: in öffentlichen Gebäuden, Hotels usw., könnte es nützlich sein, die Komforttemperatur Sets zu begrenzen, um falsche Einstellungen von Seiten des nicht autorisierten Personals zu verhindern.

Es ist also möglich, die Werte der Maximaltemperatur zu begrenzen, wenn das Thermostat im Betriebsmodus  Winter ist (Heizung) oder die Werte der Minimaltemperatur zu begrenzen, wenn das Thermostat im Betriebsmodus  Sommer (Kühlung) ist.

In der Basiskonfiguration ist keinerlei Beschränkung eingestellt.

Beispiel: Beschränkung der maximalen Komforttemperatur Sets für den Betriebsmodus Winter (Heizung)

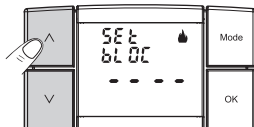

Mithilfe der Tasten \wedge oder \vee den Wert der Beschränkung der Maximaltemperatur eingeben.

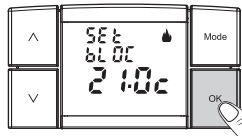

Die **OK** Taste drücken, um zur Einstellung der Beschränkung der Kühlung  zu gelangen oder sie für mindestens 4 Sekunden gedrückt halten, um die neue Einstellung zu speichern und aus dem Programmiermenü auszusteigen.

Beispiel: Beschränkung der minimalen Komforttemperatur Sets für den Betriebsmodus Sommer (Kühlung)

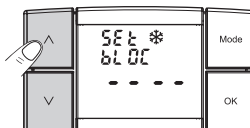

Mithilfe der Tasten \wedge oder \vee den Wert der Beschränkung der Minimaltemperatur eingeben.

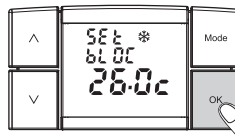

Die **OK**-Taste drücken, um die Einstellung zu speichern und zur nächsten Einstellung zu gelangen oder mindestens 4 Sek. gedrückt halten, um die neue Einstellung zu speichern und das Programmiermenü zu verlassen.

Hinweis: um eventuell zuvor eingestellte Sperren aufzuheben, die Temperatur Sets auf - - - - zurücksetzen.

MODALITÄTEN DER TEMPERATURREGELUNG

Das Thermostat funktioniert (Werkeinstellung) mit einem **Differenzial (ON/OFF)** mit auf **0,5 °C** eingestellten Differenzialtemperaturwerten (**Hysterese**). Der Hysteresewert muss der thermischen Trägheit entsprechend eingestellt sein, es wird ein niedriger Wert für Anlagen mit Heizkörpern (z.B.: gusseisern) und ein hoher Wert für Anlagen mit Ventilatorconvektoren (fan coil) empfohlen.

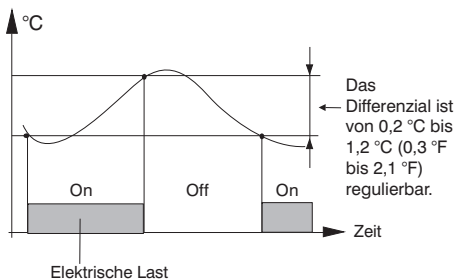

Wählen Sie die Modalität der Temperaturregulierung und stellen Sie die entsprechenden Werte gemäß den Eigenschaften Ihrer Anlage ein, wie in den folgenden Abschnitten beschrieben.

Alternativ zum Differentialmodus kann die Temperatur **PROPORTIONAL (PROP)** zur Kontrolldauer einstellbar von 7 bis 20 Minuten (Standard 10 Minuten).

Dieses System gestattet es, die gewünschte Temperatur stabiler zu halten und das Komfortempfinden für den Nutzer zu erhöhen und so beim Energieverbrauch zu sparen.

Beispiel der T Set Einstellungen: T=20 °C - Zyklus = 10 Min.

t = 20,5 °C	Anlage ständig aus
t = 20,4 °C	Anlage 1 Min. ON 9 Min. OFF
t = 20,3 °C	Anlage 2 Min. ON 8 Min. OFF
t = 20,2 °C	Anlage 3 Min. ON 7 Min. OFF
t = 20,1 °C	Anlage 4 Min. ON 6 Min. OFF
t = 20,0 °C	Anlage 5 Min. ON 5 Min. OFF
t = 19,9 °C	Anlage 6 Min. ON 4 Min. OFF
t = 19,8 °C	Anlage 7 Min. ON 3 Min. OFF
t = 19,7 °C	Anlage 8 Min. ON 2 Min. OFF
t = 19,6 °C	Anlage 9 Min. ON 1 Min. OFF
t = 19,5 °C	Anlage ständig an.

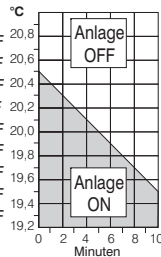

Es wird zu einem langen Zyklus bei Anlagen mit hoher thermischer Trägheit (gusseiserne Heizkörper, Fußboden-Strahlungsheizsystem) und zu einem kurzen Zyklus bei Anlagen mit geringer thermischer Trägheit geraten (fan coil).

AUSWAHL DER ART DER TEMPERATURREGELUNG (DIFFERENZIAL ON/OFF oder PROPORTIONAL)

Diese Vorgehensweise ermöglicht es, die Art der Temperaturregelung zwischen Differenzial **ON:OFF** (Werkeinstellungen) und Proportional **PROP** auszuwählen.

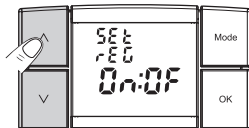

Mithilfe der Tasten \wedge oder \vee die Art der gewünschten Temperaturregelung einstellen.

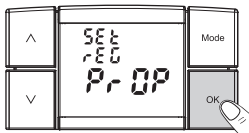

Die **OK**-Taste drücken, um die Einstellung zu speichern und zur nächsten Einstellung zu gelangen oder mindestens 4 Sek. gedrückt halten, um die neue Einstellung zu speichern und das Programmiermenü zu verlassen.

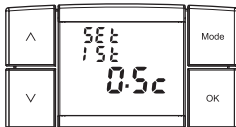

EINSTELLUNG DER HYSTERESE

Der Hysteresewert für die **ON:OFF** Regulierungsart muss der thermischen Trägheit entsprechend eingestellt sein, es wird ein niedriger Wert für Anlagen mit Heizkörpern (z.B.: gusseisern) und ein hoher Wert für Anlagen mit Ventilatorkonvektoren (fan coil) empfohlen. Der Wert ist von 0,2 °C bis 1,2 °C (0,3 °F bis 2,1 °F) regulierbar; die Werkeinstellung liegt bei 0,5 °C (0,9 °F).

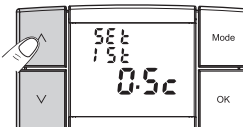

Mithilfe der \wedge oder \vee -Taste den Wert der Hysterese einstellen.



Die **OK**-Taste drücken, um die Einstellung zu speichern und zur nächsten Einstellung zu gelangen oder mindestens 4 Sek. gedrückt halten, um die neue Einstellung zu speichern und das Programmiermenü zu verlassen.

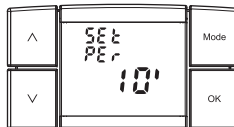

DAUER DES PROPORTIONALEN ZYKLUS

Die Dauer des Kontrollzyklus der Funktion in der **PROP** Betriebsart ist von 7 bis 20 Minuten einstellbar. Es wird zu einem langen Zyklus bei Anlagen mit hoher thermischer Trägheit (gusseiserne Heizkörper, Fußbodenheizung) und zu einem kurzen Zyklus bei Anlagen mit geringer thermischer Trägheit (fan coil). Die Werkseinstellung liegt bei 10 Minuten.

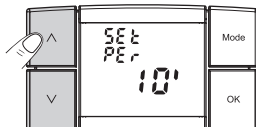

Mithilfe der \wedge oder der \vee - Tasten die Dauer des proportionalen Kontrollzyklus einstellen.

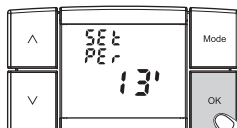

Die **OK**-Taste drücken, um die Einstellung zu speichern und zur nächsten Einstellung zu gelangen oder mindestens 4 Sek. gedrückt halten, um die neue Einstellung zu speichern und das Programmiermenü zu verlassen.

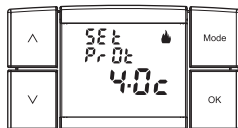

REGULIERUNG ODER AUSSCHLIESSUNG DES FROSTSCHUTZES

Im Betriebsmodus **OFF**, ist das Thermostat darauf programmiert im Frostfall, wenn die Temperatur unter $+4.0^{\circ}\text{C}$ ($+39.2^{\circ}\text{F}$) fällt, die Anlage zu schützen; diese Einstellung ist von $+4.0^{\circ}\text{C}$ bis $+12.0^{\circ}\text{C}$ ($+39.2^{\circ}\text{F}$ ÷ $+53.6^{\circ}\text{F}$) regulierbar. Es ist möglich, diese Funktion auszuschließen. In diesem Fall ist die Anlage eventuellen Frostschäden ausgesetzt.

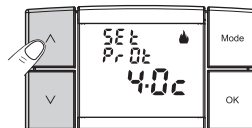

Mithilfe der \wedge oder der \vee Tasten den Wert der gewünschten Frostschutztemperatur einstellen.

Die **OK** Taste drücken, um zur Einstellung der $^{\circ}\text{C} / ^{\circ}\text{F}$ - Skala zurück zu gelangen oder sie für mindestens 4 Sekunden gedrückt halten, um die neue Einstellung zu speichern und aus dem Programmiermenü auszusteigen.

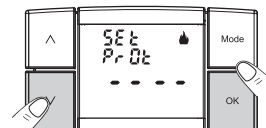

Falls es gewünscht wird den Frostschutz auszuschließen, die \vee - Taste drücken, bis auf dem Display wie in der nebenstehenden Abbildung ---- erscheint und mit der **OK**-Taste bestätigen, wie oben beschrieben.

RESET

Die Verwendung der Reset Funktion wird **dem Installateur oder erfahrenen Benutzern geraten**, da bei der Verwendung dieser Funktion alle vor rangehenden Einstellungen und Programmierungen gemäß des Gerätetyps verloren gehen. Nach Beendigung der Reset Funktion kehrt das Thermostat zu den Werkseinstellungen zurück.

Gleichzeitig die 4 Tasten des Thermostats drücken und mindestens 4 Sekunden gedrückt halten

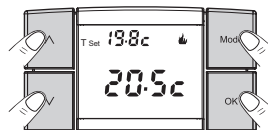

Alle Teile des Displays leuchten für einen Moment auf.

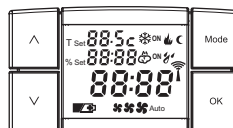

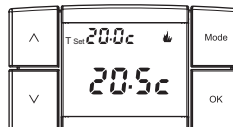

Das Thermostat nimmt den Betriebsmodus Heizung (Winter) wieder auf und es wird auf die Werkeinstellungen zurückgesetzt.



EVENTUELLE STÖRUNGEN UND PROBLEMLÖSUNGEN

DE

STÖRUNGEN	GRUND	PROBLEMLÖSUNG
Das Display des Thermostats ist ausgeschaltet <i>(Modell mit 3V dc)</i>	Batterien nicht eingelegt Polarität der Batterien falsch Batterien leer	Kontrollieren ob die Batterien eingelegt sind Die Polarität der Batterien überprüfen Die Batterien ersetzen
Das Display des Thermostats ist ausgeschaltet <i>Modell mit 230V ac</i>	Fehlende Stromzufuhr	Kontrollieren ob der Schutzschalter oder Differenzialschutz nicht in OFF - Stellung sind
Auf dem Display blinkt das Symbol  auf.	Die Batterien werden schwächer	Die Batterien innerhalb von 30 Tagen ersetzen
Auf dem Display ist ständig das Symbol  zu sehen	Die Batterien sind leer	Die Batterien ersetzen
Das Thermostat funktioniert aber die Anlage schaltet sich nicht an	Der Anlage fehlt die Spannung Das Thermostat ist nicht richtig angeschlossen	Kontrollieren ob der Schutzschalter oder Differenzialschutz nicht in OFF - Stellung sind Mit dem Installateur Kontakt aufnehmen
Die Temperatur schwankt zu sehr zwischen Warm und Kalt	Das Thermostat ist nicht der Anlage gemäß eingestellt	Mit dem Installateur Kontakt aufnehmen
Die Betriebsfunktion OFF, das Temperatur Set Frostschutz, wird nicht angezeigt	Die Frostschutztemperatur wurde ausgeschlossen	Die Frostschutztemperatur einstellen, die im Kapitel PROGRAMMIERBARE FUNKTIONEN enthaltenen Angaben befolgen

ÍNDICE

ESPAÑOL

DATOS TÉCNICOS	pág. 75
VISTA GENERAL Y FUNCIONES DE LAS TECLAS	pág. 76
INSTALACIÓN	pág. 77
INSTRUCCIONES DE USO	pág. 81
FUNCIONES PROGRAMABLES SEGÚN EL TIPO DE INSTALACIÓN	pág. 84
OPERACIÓN DE RESET	pág. 90
EVENTUALES PROBLEMAS Y SOLUCIONES	pág. 91



ADVERTENCIAS



Leer atentamente el presente manual antes de utilizar el producto, en él se encuentran las indicaciones importantes relativas a la seguridad, a la instalación y al uso. Debe conservarse con diligencia para futuras consultas.



La instalación y la conexión eléctrica del termostato deben ser realizadas únicamente por electricistas especializados, de conformidad con las normas y leyes vigentes.





Antes de realizar cualquier trabajo en el dispositivo corte la alimentación de red de 230V~

- Si en el display aparece la temperatura ambiente 0°C o $+37.7^{\circ}\text{C}$ ($+32^{\circ}\text{F}$ o $+99.9^{\circ}\text{F}$) en forma parpadeante significa que la temperatura registrada sobrepasa los límites de escala.
- Si el display visualiza "----" parpadeante indica que la sonda está averiada, y cada actividad de termostato es suspendida.
- **Modelo de 3V dc:** utilizar 2 pilas alcalinas de 1,5V tipo AAA (LR03), cualquier otra que no sea idónea puede alterar la programación configurada.
N.B.: el producto ha sido certificado, y sus características se garantizan con pilas alcalinas DURACELL o ENERGIZER.
- **Modelo de 230V ac:** después de instalar y de ajustar el termostato, si el display se apaga por falta de energía, toda la programación efectuada queda grabada, y cuando regresa la alimentación a la red y el display se enciende, el dispositivo retorna a su normal funcionamiento.
- Si es necesario limpiar el termostato, use un paño ligeramente húmedo.
- El fabricante se reserva la facultad de introducirle modificaciones a los diseños o a la parte técnica cuando lo considere conveniente, sin estar obligado a dar previo aviso.

DATOS TÉCNICOS

ES

Tensión de alimentación: _____	modelo con 2 pilas de 1,5V Alcalinas tipo AAA (LR03) modelo con tensión de red 230V 50÷60Hz
Autonomía modelos con pilas: _____	2 años aprox.
Autonomía del encendido del display con el símbolo parpadeante  de pilas descargadas: _____	1 mes aprox.
Tipo de acción, desconexión y aparato: _____	1/B/ Electrónico
Tipo de salida: _____	relé de contacto con cambio NO / COM / NC libre de potenciales máx 5 (3) A / 250V~ de clase A
Software: _____	4 kV
Tensión impulsiva nominal: _____	2 conductores (sólo en modelos con alimentación de 230V~)
Conexión alimentación de red: _____	2 o 3 conductores
Conexión equipo (carga): _____	1,5 mm ² ÷ 2,5 mm ²
Sección cables con bornes: _____	CONFORT y REDUCCIÓN NOCTURNA + ANTICONGELACIÓN (OFF)
Niveles de Temperatura: _____	0 °C ÷ +37,7 °C / +32 °F ÷ +99,9 °F
Campo de visualización temperatura ambiente: _____	0,1°C / 0,1°F
Resolución temperatura ambiente: _____	+5 °C ÷ +37,7 °C / +41,0 °F ÷ +99,9 °F (limitable)
Campo de regulación T Set de temperatura: _____	0,1 °C / 0,1 °F
Resolución temperatura de set: _____	+4 °C ÷ + 12 °C / 39,2 °F ÷ 53,6 °F (regulable/excluíble)
Temperatura anticongelación: _____	± 0,5 °C / ± 0,9 °F
Tolerancia en la lectura de temperatura: _____	
Tipo de regulación de temperatura:	
- ON/OFF con diferencial _____	regulable de 0,2 °C a 1,2°C / de 0,3 °F a 2,1 °F (default 0,5 °C / 0,9 °F)
- Proporcional con período de control _____	regulable de 7 a 20 minutos (default 10 minutos)
Clasificación energética: _____	ErP: Class I; 1% Reg. EU 811/2013
Gradiente térmico: _____	1°K / 15 min
Grado de protección: _____	IP 30
Clase de aislamiento: _____	II 
Grado de contaminación: _____	normal
Límites Temperatura de funcionamiento: _____	0 °C ÷ +50 °C / +32 °F ÷ +122 °F
Límites Temperatura de almacenamiento: _____	-10 °C ÷ +65 °C / +14 °F ÷ +149 °F
Normativas de referencia para la marca CE: _____	LVD - EMC EN60730-1 EN60730-2-9

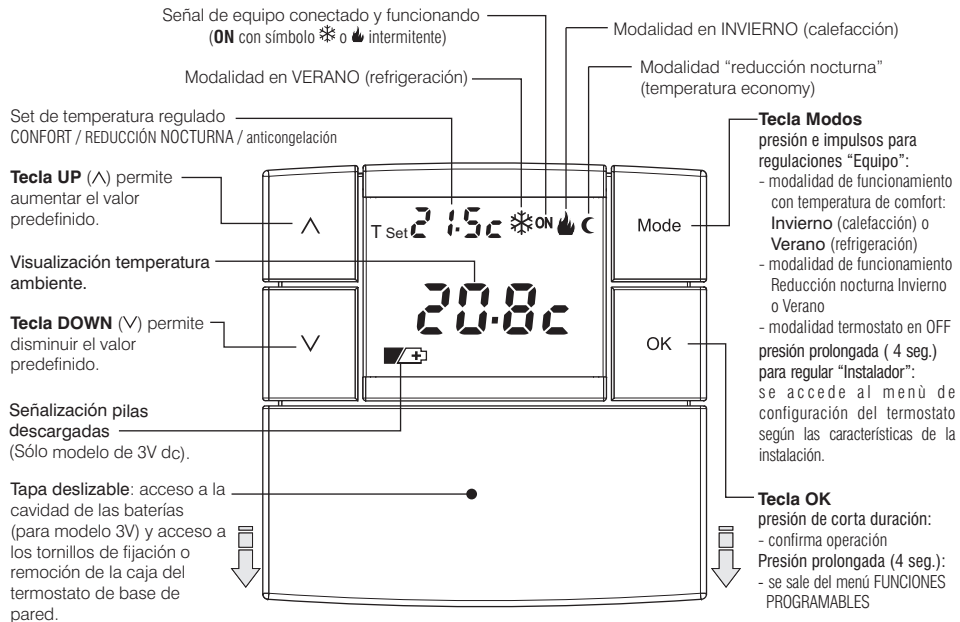

INSTALACIÓN

ES

EJEMPLO DE INSTALACIÓN

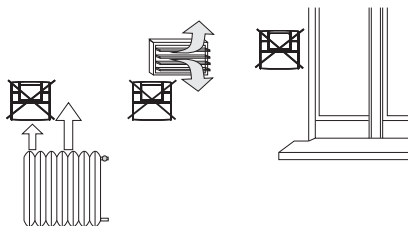
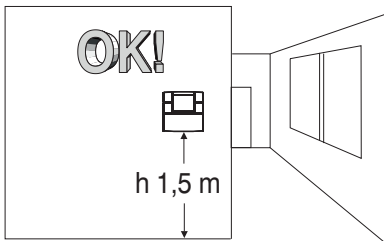

Instalar el termostato preferiblemente a una cuota de $1,50 \div 1,70$ m del suelo; lejos de fuentes de calor, tomas de aire, puertas, ventanas o cualquier otra cosa que pueda influenciar su funcionamiento.

DIMENSIONES TOTALES

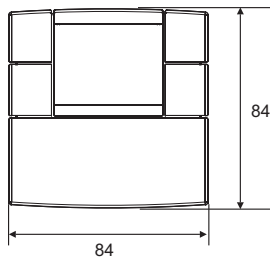

Instalación en pared

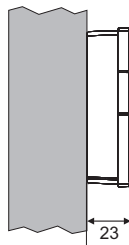

Instalación en pared
con caja empotrable redonda

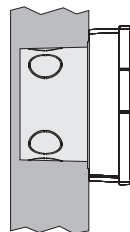

OPERACIONES PRELIMINARES

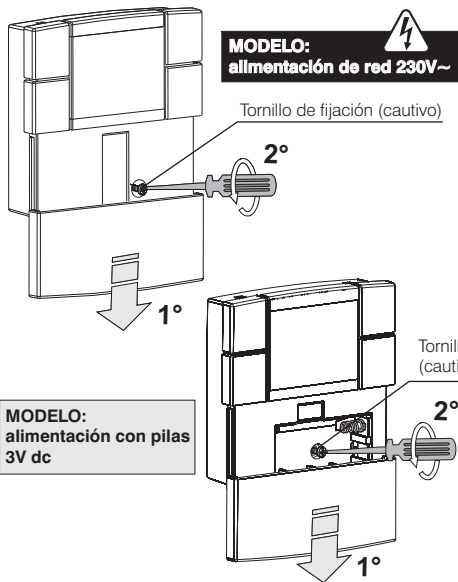

Después de aflojar el tornillo de fijación, separar la base del termostato ejerciendo presión con un destornillador en la cavidad que está en la parte inferior del dispositivo.

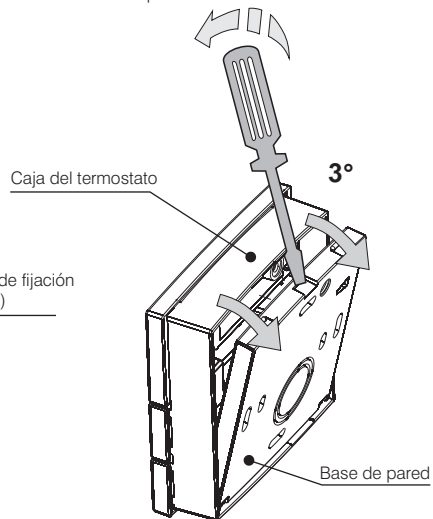

INSTALACIÓN

ES

BASE DE PARED Y BORNES

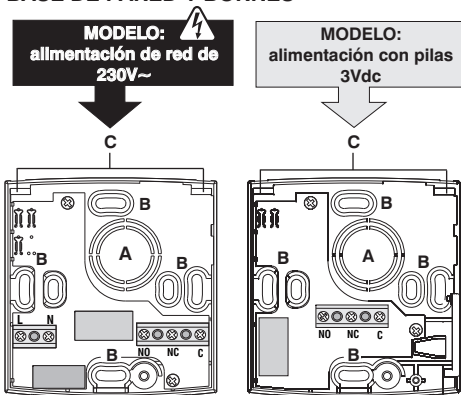

- A - Orificio para cables de:**
Caja empotrable redonda o tubo corrugado
- B - Agujeros de fijación para la base:**
De pared o en caja empotrable redonda
- C - Huecos para anclaje del termostato**

INSTALACIONES ELÉCTRICAS

Desactivar la tensión de red de 230V~ 
Conectar la alimentación de red de 230V~ a los bornes:

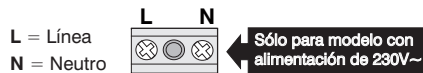

Conectar el dispositivo para el manejo de los bornes:
NO = contacto normalmente abierto
NC = contacto normalmente cerrado
C = común

Ejemplos de conexiones eléctricas

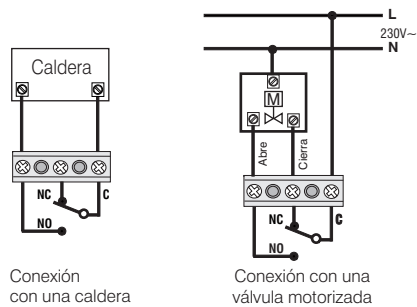

Conexión con una caldera

Conexión con una válvula motorizada

FIJACIÓN Y REMOCIÓN DEL TERMOSTATO

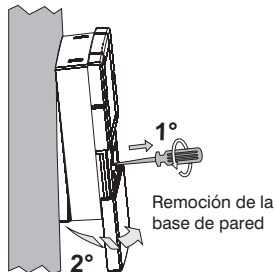
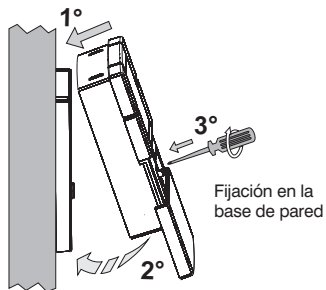

SÓLO MODELO ALIMENT. DE PILAS (3Vdc)

COLOCACIÓN O SUSTITUCIÓN DE PILAS

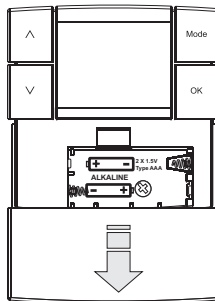

Colocar o sustituir con 2 pilas de 1,5V tipo AAA - LR03 poniendo atención a la polaridad.

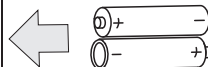

Utilizar pilas alcalinas de buena calidad (Se recomiendan pilas Duracell o Energizer).



Eliminar las pilas usadas botándolas en los contenedores especiales teniendo en cuenta lo previsto en las normas sobre protección del ambiente.

Atención: la duración de las pilas puede ser superior a 2 años. De todas maneras se recomienda sustituirlas cada 24 meses para evitar que se agoten en períodos de inactividad (ej. vacaciones navideñas, etc.)

INSTRUCCIONES DE USO

ES

MODALIDAD DE FUNCIONAMIENTO

El termostato tiene 5 modalidades de funcionamiento:

 **INVIERNO** = calefacción (regulación de fábrica)
con temperatura de **CONFORT**

 **Reducción nocturna invierno** = calefacción
con temperatura de **REDUCCIÓN** (ahorro)

OFF Termostato apagado

- *Calefacción en funcionamiento*: está activada la modalidad temperatura anticongelación
- *Refrigeración en funcionamiento*: la instalación está totalmente desactivada

 **VERANO** = enfriamiento
con temperatura de **CONFORT**

 **Reducción nocturna verano** = enfriamiento
Con temperatura de **REDUCCIÓN** (ahorro)

CAMBIO MODALIDAD DE FUNCIONAMIENTO

Cambio de temperatura de CONFORT a temperatura de REDUCCIÓN y viceversa

Pulsar una vez la tecla **Mode**, el símbolo y la temperatura configurada parpadean, pulsar la tecla **OK** por 5 segundos para confirmar.

Cambio de FUNCIONAMIENTO NORMAL a OFF

Pulsar 2 veces la tecla **Mode**, la señal **OFF** y la temperatura anticongelación configurada parpadean, pulsar la tecla **OK** por 5 segundos para confirmar.

Cambio de INVIERNO a VERANO y viceversa

Pulsar 3 veces la tecla **Mode**, el símbolo y la temperatura configurada parpadean, pulsar la tecla **OK** por 5 segundos para confirmar.

Cambio de OFF a FUNCIONAMIENTO NORMAL

Pulsar 1 vez la tecla **Mode** para volver a la modalidad de funcionamiento anterior.

*ejemplo: funcionamiento
calefacción activa*

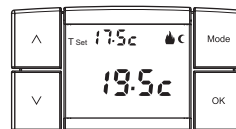
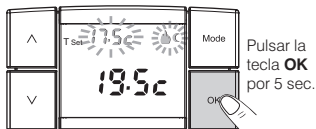
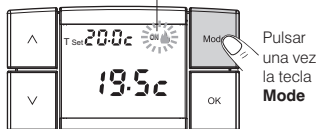

En estas figuras se muestra el paso de la modalidad **INVIERNO** con temp. **CONFORT** a la temp. **REDUCCIÓN**

MODIFICACIÓN DE LA TEMPERATURA Set CONFIGURADA

Desde el modo actual es posible modificar la configuración de la temperatura T Set pulsando directamente las teclas \wedge o \vee , quedando grabada inmediatamente la nueva configuración.

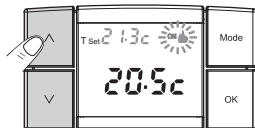

Nota: cada vez que se presionan las teclas \wedge o \vee se presenta una variación de 0,1 grados; teniéndolos presionados se obtiene el desplazamiento rápido de los valores.

Nota: los Set de temperatura máxima y mínima se pueden bloquear (ver cap. FUNCIONES PROGRAMABLES).

O también:

Pulsando una o varias veces la tecla **Mode** hasta visualizar el modo de funcionamiento deseado.

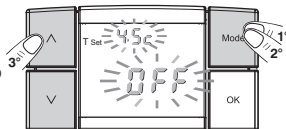

En 5 segundos,

Pulsar \wedge para aumentar el valor T Set configurado o el tasto \vee para disminuirlo.

Transcurridos 5 segundos desde la última presión de una tecla, el termostato vuelve a su funcionamiento anterior.

Nota: si la temperatura antihielo se ha excluido (ver cap. FUNCIONES PROGRAMABLES), el usuario no podrá modificar el Set de temperatura antihielo.

IMPORTANTE: el termostato permite configurar T Set de +5 °C a 37,7 °C (+41,0 °F ÷ +99,9 °F) con valores de temperatura que satisfacen las siguientes condiciones:

Invierno: configuración de temperatura de "Confort" mayor o igual a la temperatura de "Reducción" invierno.

Verano: configuración de temperatura de "Confort" menor o igual a la temperatura de "Reducción" verano.

Las temperaturas T Set configuradas de fabrica son:

	Modalidad invierno (calefacción): temperatura Confort 20,0 °C / 68,0 °F Caldera funcionando con temperatura ambiente inferior a 20,0 °C / 68,0 °F
	Reducción nocturna invierno: Temperatura "Reducción" 17,5 °C / 63,5 °F Caldera funcionando con temperatura ambiente inferior a 17,5 °C / 63,5 °F
	Modalidad verano (refrigeración): temperatura "Confort" 25,0 °C / 77,0 °F Acondicionador funcionando con temperatura ambiente superior a 25,0 °C / 77,0 °F
	Reducción nocturna verano: temperatura "Reducción" 28,0 °C / 82,4 °F Acondicionador funcionando con temperatura ambiente superior a 28,0 °C / 82,4 °F
	OFF Termostato apagado (modalidad anticongelación): temperatura Anticongelación 4,0 °C / 39,2 °F (regulable/excluíble) - Caldera funcionando con temperatura ambiente inferior a 4,0 °C / 39,2 °F - Acondicionador desactivado.

INSTRUCCIONES DE USO

SÓLO MODELO ALIMENTACIÓN DE PILAS (3Vdc)

SEÑAL DE PILAS CASI DESCARGADAS O DESCARGADAS

Cuando aparece el símbolo  parpadeante, indica que las pilas están para agotarse, por lo que desde este momento se dispone de 30 días para sustituirlas.

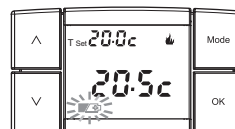

Si durante este tiempo no se sustituyen las pilas, el display se apagará, visualizando sólo el símbolo  permanente.

Cada actividad de termostatación se suspenderá y todas las configuraciones quedan grabadas para posteriormente ser restauradas al introducirse las nuevas pilas.

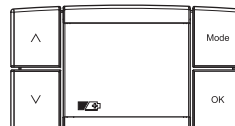

SÓLO EN MODELO DE ALIMENTACIÓN DE 230V ac

FALTA DE TENSIÓN EN LA RED

En caso de falta de alimentación de la red, el display del termostato se apaga completamente, desactivando la termostatación y grabando las configuraciones en la memoria, cuando se restaura la alimentación, el display se enciende y el dispositivo vuelve a su funcionamiento normal.

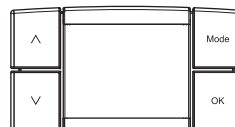

ACCESO A LA PROGRAMACIÓN

El acceso a la programación está recomendado a los **instaladores o usuarios expertos**, toda vez que la modificación de algunas configuraciones puede comprometer el correcto funcionamiento de la instalación.

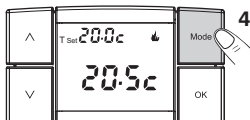

4 seg.

Tener pulsada la tecla **Mode** por 4 seg.

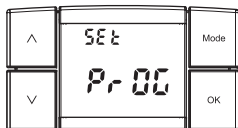

El display muestra por algunos instantes la leyenda SET PROG.

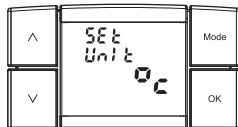

Luego, el termostato se desplaza a la página de configuración de la unidad de medida.

Dentro del menú de programación se pasa de una función a otra pulsando la tecla **Mode** con la siguiente secuencia:

- Configuración de la escala de la temperatura (°C o °F)
- Corrección de la temperatura ambiente medida (OFFSET)
- Bloqueos de los Set de temperatura
- Selección de la modalidad de regulación de la temperatura: (DIFERENCIAL ON/OFF o PROPORCIONAL)
- Modificación del valor de histéresis configurado (Diferencial on/off)
- Modificación del ciclo de duración configurado (Proporcional)
- Exclusión o configuración temperatura anticongelación



Pulsar la tecla **Mode** una o varias veces para pasar de una función a otra.

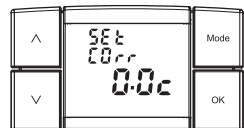

IMPORTANTE: para salir del menú de programación adoptando las nuevas configuraciones, confirmar con la tecla OK, haciendo lo siguiente:

Pulsar durante 4 segundos la tecla OK, o esperar 60 segundos (time-out); el termostato volverá a funcionamiento normal.

FUNCIONES PROGRAMABLES SEGÚN EL TIPO DE INSTALACIÓN

ES

CONFIGURACIÓN DE LA ESCALA DE TEMPERATURA

El termostato se programa en fábrica para visualizar la temperatura en grados centígrados (Celsius), pero se puede pasar a la escala Fahrenheit o viceversa, realizando la siguiente operación:

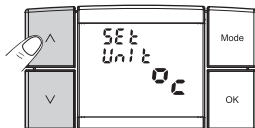

Pulsar la tecla \wedge o \vee para modificar la actual configuración.

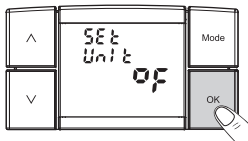

Pulsar la tecla **OK** para memorizar y pasar a la configuración siguiente o tenerlo pulsado por 4 seg. para grabar la nueva configuración y salir del menú de programación.

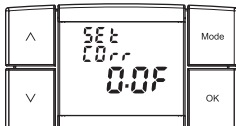

CORRECCIÓN DE LA LECTURA DE LA TEMPERATURA AMBIENTE

Si por cualquier motivo el termostato debe instalarse en una posición en la que la medida de la temperatura pueda ser influenciada (ej muro perimetral que en invierno es más frío que el resto de la habitación), es posible configurar un Offset (valor de corrección) de la temperatura medida, con lo cual la corrección es configurable de -2°C a $+2^{\circ}\text{C}$ o de -3.6 a $+3.6^{\circ}\text{F}$.

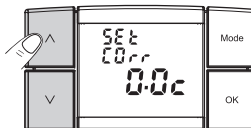

Pulsar la tecla \wedge o \vee para modificar la actual configuración.



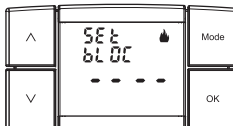

Pulsar la tecla **OK** para memorizar y pasar a la configuración siguiente o tenerlo pulsado por 4 seg. para grabar la nueva configuración y salir del menú de programación.



BLOQUEO DEL SET DE TEMPERATURA MÁX (invierno) Y MIN (verano)

En algunos casos de instalación del termostato, como por ejemplo, edificios públicos, hoteles, etc., puede ser de mucha utilidad limitar el set de temperatura confort con el fin de evitar configuraciones equivocadas por parte de personal no autorizado.

Es posible limitar los valores de Set de temperatura máxima si el termostato se encuentra en la modalidad  **Invierno** (calefacción), o limitar los valores de Set de temperatura mínima si el termostato está en modalidad  **Verano** (refrigeración). En la configuración de base no está programado bloqueo alguno.

Ejemplo: bloqueo del set de temperatura Confort máxima para la modalidad Invierno (calefacción)

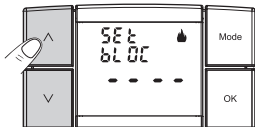

Con las teclas \wedge o \vee configurar el valor de la temperatura máxima a bloquear.

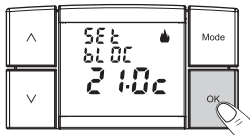

Pulsar la tecla **OK** para memorizar y pasar a la configuración del bloqueo para la  **Refrigeración** o tenerlo pulsado por 4 seg. para grabar la nueva configuración y salir del menú de programación.

Ejemplo: bloqueo del set de temperatura Confort mínima para la modalidad Verano (refrigeración)

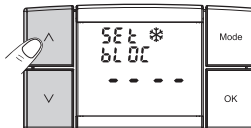

Con las teclas \wedge o \vee configurar el valor de la temperatura mínima a bloquear.

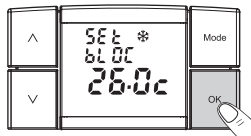

Pulsar la tecla **OK** para memorizar y pasar a la siguiente configuración o tenerlo pulsado por 4 seg. para grabar la nueva configuración y salir del menú de programación.

Nota: para cancelar fijaciones configuradas con anterioridad, mover los Set a - - - -

MODALIDAD DE REGULACIÓN DE LA TEMPERATURA

El funcionamiento del termostato (configuración de fábrica) es en modo diferencial (ON/OFF) con un valor térmico (histéresis) predefinido en 0,5 °C.

El valor histéresis debe configurarse con base en la inercia térmica de la instalación, se aconseja un valor bajo para instalaciones con radiadores (Ej. en arrabio), y un valor alto para instalaciones con fan-coil.

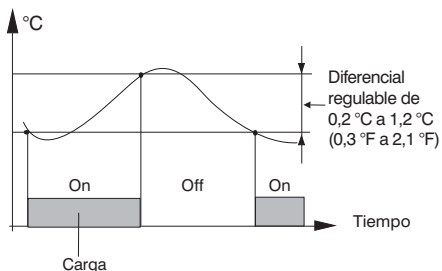

En lugar del funcionamiento diferencial es posible que la temperatura se ajuste en modo **PROPORCIONAL (PROP)** con período de control regulable de 7 a 20 minutos (default 10 minutos); esto permite que la temperatura gane estabilidad, aumentando la sensación de confort y reduciendo el consumo energético.

Ejemplo de configuración:

t set = 20 °C - Ciclo = 10 min

t = 20,5°C	Equipo siempre apagado
t = 20,4°C	Equipo 1 min ON - 9 min OFF
t = 20,3°C	Equipo 2 min ON - 8 min OFF
t = 20,2°C	Equipo 3 min ON - 7 min OFF
t = 20,1°C	Equipo 4 min ON - 6 min OFF
t = 20,0°C	Equipo 5 min ON - 5 min OFF
t = 19,9°C	Equipo 6 min ON - 4 min OFF
t = 19,8°C	Equipo 7 min ON - 3 min OFF
t = 19,7°C	Equipo 8 min ON - 2 min OFF
t = 19,6°C	Equipo 9 min ON - 1 min OFF
t = 19,5°C	Equipo siempre encendido

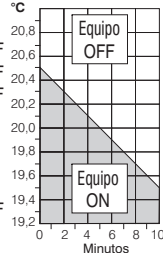

Se recomienda un ciclo prolongado para instalaciones con inercia térmica alta (radiadores en arrabio, sistemas radiantes de suelo) y un ciclo breve para instalaciones con inercia térmica baja (fan-coil).

Elegir el modo de regulación de la temperatura y configurar los valores según las características del propio sistema, como se indica en los apartados siguientes.

SELECCIÓN DE LA MODALIDAD DE REGULACIÓN DE LA TEMPERATURA (DIFERENCIAL ON/OFF o PROPORCIONAL)

Esta operación permite seleccionar la modalidad de regulación de la temperatura, entre funcionamiento Diferencial ON:OFF (programación de fábrica) y Proporcional PROP.

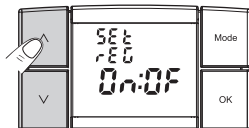

Con las teclas \wedge o \vee configurar la modalidad de regulación de la temperatura deseada.

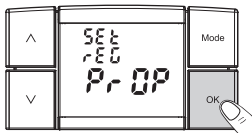

Pulsar la tecla **OK** para memorizar y pasar a la siguiente configuración o tenerlo pulsado por 4 seg. para grabar la nueva configuración y salir del menú de programación.

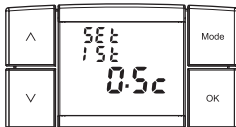

CONFIGURACIÓN DE LA HISTÉRESIS

El valor de histéresis para la modalidad de regulación **ON:OFF** debe configurarse con base en la inercia térmica de la instalación, se aconseja un valor bajo para instalaciones con radiadores (ej. en arrabio) y un valor alto para instalaciones con fan-coil. El valor puede configurarse de 0,2 °C a 1,2 °C (0,3 °F a 2,1 °F); la configuración de fábrica es de 0,5 °C (0,9 °F).

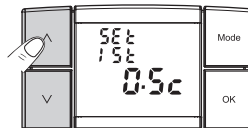

Con las teclas \wedge o \vee configurar el valor de histéresis.



Pulsar la tecla **OK** para memorizar y pasar a la siguiente regulación o tenerlo pulsado por 4 seg. para grabar la nueva configuración y salir del menú de programación.

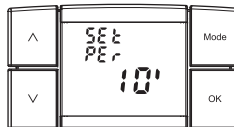

FUNCIONES PROGRAMABLES SEGÚN EL TIPO DE INSTALACIÓN

ES

DURACIÓN DEL CICLO PROPORCIONAL

La duración del ciclo de control para el funcionamiento en la modalidad **PROP** es programable de **7 a 20 minutos**; se aconseja un ciclo más largo para instalaciones con inercia térmica alta (radiadores en arrabio, sistemas radiantes de suelo) y un ciclo breve para instalaciones con inercia térmica baja (fan-coil). La programación de fábrica es de **10 minutos**.

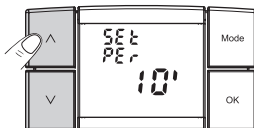

Con las teclas \wedge o \vee configurar la duración del ciclo de control proporcional.

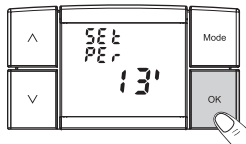

Pulsar la tecla **OK** para memorizar y pasar a la siguiente configuración o tenerlo pulsado por 4 seg. Para grabar la nueva configuración y salir del menú programación.

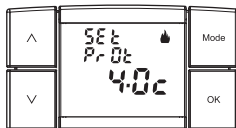

REGULACIÓN O EXCLUSIÓN DE LA PROTECCIÓN ANTICONGELACIÓN

En la modalidad de funcionamiento **OFF**, el termostato está programado para proteger la instalación en caso de congelación con temperaturas bajo los $+4.0^{\circ}\text{C}$ ($+39.2^{\circ}\text{F}$); esta configuración es regulable de $+4.0^{\circ}\text{C}$ a $+12.0^{\circ}\text{C}$ ($+39.2^{\circ}\text{F}$ \div $+53.6^{\circ}\text{F}$). Esta función se puede excluir, en estos casos la instalación estará expuesta a los daños que pueda ocasionarle la congelación.



Con las teclas \wedge o \vee configurar el valor de la temperatura anticongelación deseada.

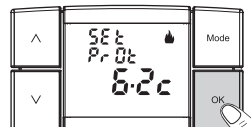

Pulsar la tecla **OK** para memorizar y volver a la configuración de la escala $^{\circ}\text{C}/\text{F}$ o tenerlo pulsado por 4 seg. para grabar la nueva configuración y salir del menú de programación.

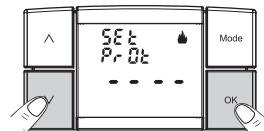

Si en cambio, se desea suprimir la protección anticongelación, pulsar la tecla \vee hasta visualizar en el display **---** como en la figura de al lado y confirmar con la tecla **OK** como se describe en la parte superior.

RESET

La operación de Reset está recomendada para **instaladores y usuarios con experiencia**, porque borra todas las configuraciones y la programaciones realizadas con anterioridad según el tipo de instalación.

Terminada la operación de Reset, el termostato restablece todas las configuraciones de fabricación.

Pulsar contemporáneamente las 4 teclas del termostato y mantenerlas pulsadas por 4 segundos aproximadamente.

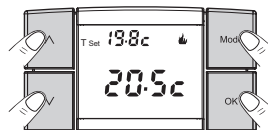

Todos los segmentos del display se encienden por un instante.

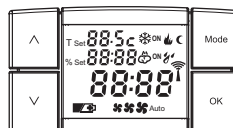

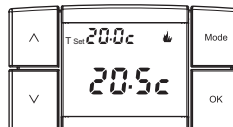

El termostato vuelve a funcionar en la modalidad Calefacción (invierno), restableciendo todas las configuraciones de fabricación.



EVENTUALES PROBLEMAS Y SOLUCIONES

ES

PROBLEMA	CAUSA	SOLUCIÓN
El display del termostato está apagado (Modelo de 3Vdc)	Pilas sin instalar Errada polaridad de las pilas Pilas agotadas	Controlar que las pilas estén instaladas Comprobar la polaridad de las pilas Sustituir las pilas
El display del termostato está apagado (Modelo de 230V ac)	Falta tensión en la red	Controlar que el interruptor o diferencial de protección no esté en OFF
En el display aparece el símbolo  parpadeante	Las pilas están para agotarse	Sustituir las pilas dentro de 30 días
En el display aparece solamente el símbolo  permanente	Las pilas están agotadas	Sustituir las pilas
El termostato funciona pero la instalación no se activa	Instalación sin tensión El termostato no está conectado correctamente.	Controlar que el interruptor o diferencial de protección no esté en OFF Llamar al instalador
La temperatura oscila mucho entre calor y frío.	El termostato no está configurado correctamente para el tipo de instalación.	Llamar al instalador
En funcionamiento OFF el set de temperatura antihielo no se visualiza	La temperatura antihielo ha sido suprimida	Configurar la temperatura antihielo siguiendo las indicaciones descritas en el cap. FUNCIONES PROGRAMABLES

IT**SMALTIMENTO A "FINE VITA" DI APPARECCHI ELETTRICI ED ELETTRONICI**

Questo simbolo sul prodotto o sul suo imballo indica che questo prodotto non può essere trattato come rifiuto domestico. Al contrario, dovrà essere portato ad un punto di raccolta determinato per il riciclaggio degli apparecchi elettrici ed elettronici, come ad esempio:

- punti vendita, nel caso si acquisti un prodotto nuovo simile a quello da smaltire;
- punti di raccolta locali (centri di raccolta rifiuti, centri locali di riciclaggio, ecc...).

AssicurandoVi che il prodotto sia smaltito correttamente, aiuterete a prevenire potenziali conseguenze negative per l'ambiente e la salute, che potrebbero essere causate da un inadeguato smaltimento di questo prodotto.

Il riciclaggio dei materiali aiuterà a conservare le risorse naturali. Per informazioni più dettagliate riguardo il riciclaggio di questo prodotto, contattate per cortesia il Vs. ufficio locale, il Vs. servizio di smaltimento rifiuti domestici o il negozio dove avete acquistato questo prodotto.

**EN****DISPOSAL OF ELECTRICAL & ELECTRONIC EQUIPMENT**

This symbol on the product or its packaging to indicates that this product shall not be treated as household waste. Instead, it shall be handed over to the applicable collection point for the recycling of electrical and electronic equipment, such as for example:

- sales points, in case you buy a new and similar product;
- local collection points (waste collection centre, local recycling center, etc...).

By ensuring this product is disposed of correctly, you will help prevent potential negative consequence for the environment and human health, which could otherwise be caused by inappropriate waste handling of this product.

The recycling of materials will help to conserve natural resources. For more detailed information about recycling of this product, please contact your local city office, your house hold waste disposal service or the shop where you purchased the product.

**FR****TRAITEMENT DES APPAREILS ÉLECTRIQUES ET ÉLECTRONIQUES EN FIN DE VIE**

Ce symbole, apposé sur le produit ou sur son emballage, indique que ce produit ne doit pas être traité avec les déchets ménagers. Il doit être remis à un point de collecte approprié pour le recyclage des équipements électriques et électroniques:

- dans les points de distribution en cas d'achat d'un équipement équivalent;
- dans les points de collecte mis à votre disposition localement (déchetterie, collecte sélective, etc...).

En s'assurant que ce produit est bien mis au rebut de manière appropriée, vous aiderez à prévenir les conséquences négatives potentielles pour l'environnement et la santé humaine. Le recyclage des matériaux aidera à conserver les ressources naturelles. Pour toute informations supplémentaire au sujet du recyclage de ce produit, vous pouvez contacter votre municipalité, votre déchetterie ou le magasin où vous avez acheté le produit.



DE

ENTSORGUNG VON GEBRAUCHTEN ELEKTRISCHEN UND ELEKTRONISCHEN GERÄTEN

Dieses Symbol auf dem Produkt oder seiner Verpackung weist darauf hin, dass dieses Produkt nicht als normaler Haushaltsabfall zu behandeln ist, sondern an einer Annahmestelle für Recycling von elektrischen oder elektronischen Geräten abgegeben werden muss, wie zum Beispiel:

- an den Verkaufsstellen, falls Sie ein ähnliches Neugerät kaufen;
- an den örtlichen öffentlichen Sammelstellen (Wertstoffhof, Recyclingsammelstellen, usw..).



Durch Ihren Beitrag zum korrekten Entsorgen dieses Produktes schützen Sie die Umwelt und die Gesundheit Ihren Mitmenschen. Umwelt und Gesundheit werden durch falsches Entsorgen gefährdet. Materialrecycling hilft den Verbrauch von Rohstoffen zu verringern. Weitere Information über das Recycling dieses Produktes erhalten Sie von Ihrer Gemeinde, den kommunalen Entsorgungsbetrieben oder dem Geschäft, in dem Sie das Produkt gekauft haben.

ES

TRATAMIENTO DE LOS APARATOS ELÉCTRICOS Y ELECTRÓNICOS EN FINAL DE VIDA

Este símbolo, colocado en el producto o en su embalaje, indica que este producto no debe ser tratado con los desechos domésticos.

Debe depositarse en un punto de colecta apropiado para el reciclaje de los equipos eléctricos y electrónicos:

- en los puntos de distribución en caso de compra de un equipo equivalente;
- en los puntos de colecta puestos a su disposición localmente (vertedero, colecta selectiva, etc..).



Asegurándose que el producto se desecha de manera apropiada, ayudará a prevenir las potenciales consecuencias negativas sobre el medio ambiente y la salud humana. El reciclaje de los materiales ayudará a conservar los recursos naturales. Para cualquier información complementaria al respecto de este producto, puede contactar con su ayuntamiento, el vertedero de su localidad, o el almacén dónde se compró el producto.





A series of ten horizontal lines, spaced evenly down the page, providing a guide for handwriting practice. The lines are parallel and extend across most of the page width.

